



## 2019 PRICELIST €



#### SUNBRELLA CUSHION FABRICS

QUICK PICK: NATTE DARK TAUPE – NATTE CARBON BEIGE  
CAT. A: SOLIDS & STRIPES – SOLIDS PREMIUM – BENGALI – CHECKS – DUPIONE – HERITAGE – NATTE – SLING LOGAN/AUGUSTINE  
CAT. B (+ PRICE SUPPLEMENT): CHARTRES – DEAUVE – HEXAGON – KANOKO – LOPI – MARBLE – MOSAIC – PALAZZO – ROBBEN – SAVANE – SLING SAILING – TUNDRA

LEAD TIME FOR ALL SUNBRELLA FABRICS: 2 – 4 WEEKS

---

## ICONS



**TOTAL VOLUME**  
THE TOTAL VOLUME OF THE FURNITURE INDICATES THE VOLUME OF ALL PACKED PARTS OF A COMPLETE PRODUCT  
FOR MORE DETAILED INFORMATION CHECK THE PRODUCT PACKAGING DATA SHEET



**TOTAL WEIGHT**  
THE TOTAL WEIGHT OF THE FURNITURE INDICATES THE WEIGHT OF ALL PACKED PARTS OF A COMPLETE PRODUCT  
FOR MORE DETAILED INFORMATION CHECK THE PRODUCT PACKAGING DATA SHEET

ALL DIMENSIONS ARE IN CM – ALL WEIGHTS ARE IN KGS – ALL VOLUMES ARE IN M3

## SPECIAL FEATURES:



**ITEM WITH ADJUSTABLE FEET**  
THIS ICON IS USED FOR FURNITURE EQUIPED WITH ADJUSTABLE FEET, SO A STABILIZED AND LEVELED INSTALLATION OF THE ITEM IS POSSIBLE ON ALMOST ANY SURFACE



**ITEM WITH WHEELS**  
THIS ICON IS USED FOR FURNITURE EQUIPED WITH 2 OR MORE WHEELS FOR EASY MOVING

## PRICELIST CONTENTS

CIMA COLLECTION	4
CUSHIONS CIMA COLLECTION	17
LOUNGE COLLECTION	20
MODULAR LOUNGE SETS	25
MODULAR LOUNGE SYSTEM PARTS	26
CUSHIONS LOUNGE COLLECTION	29
SHELL COLLECTION	34
CUSHIONS SHELL COLLECTION	38
ACCESSORIES & DECORATIONS	39
MATERIALS & FABRIC	42

FUERADENTRO RESERVES THE RIGHT TO ADJUST OUR PRICES AND MODELS AT ANY TIME. COLOURS ARE NOT BINDING.

### COPYRIGHT

ALL FUERADENTRO DESIGNS, NAMES, PHOTOS AND INTELLECTUAL PROPERTY USED IN THIS BROCHURE ARE THE COPYRIGHT OF FUERADENTRO. ANY INFRINGEMENT OR ABUSE OF OUR COPYRIGHT WILL BE PURSUED BY LAW. FUERADENTRO ALWAYS RESERVES THE RIGHT TO MAKE CHANGES OR ADDITIONS TO THE DESCRIPTIONS OR FEATURES GIVEN IN THIS BROCHURE IN THE LIGHT OF TECHNICAL DEVELOPMENTS OR AVAILABILITY OF MATERIALS. WE ARE NOT RESPONSIBLE FOR VARIATIONS IN COLOUR, WEIGHT OR DIMENSIONS, AS VARIATIONS ARE POSSIBLE WHENEVER PRODUCTS ARE HAND-MADE.

ALL FUERADENTRO DESIGNS ARE REGISTERED TRADEMARKS AND COPYRIGHTED BY FUERADENTRO. OUR TRADEMARK IS PROTECTED BY LAW AND ALL INFRINGEMENTS AGAINST OUR TRADEMARK AND OUR COPYRIGHT WILL BE PURSUED BY LAW.

# CIMA COLLECTION

## PRODUCT

### SILLÓN CHAIR



FRAME:		BRUSHED STAINLESS STEEL	ELECTRO POLISHED STAINLESS STEEL	POWDERCOATED STAINLESS STEEL WHITE	POWDERCOATED STAINLESS STEEL CENDRE	POWDERCOATED STAINLESS STEEL BLACK	TEAK
SEAT:							
BATYLINE®	WHITE	-	€ 790 SLNEPWU	-	-	-	-
	CENDRE	-	€ 790 SLNEPCE	-	-	-	-
	BLACK	-	€ 790 SLNEPZU	-	-	-	-
SEAT + BACK CUSHION		SLIM TEMPOTEST®   SUNBRELLA®/CAT.A € 80   € 140 FOR MORE INFORMATION ABOUT CUSHIONS SEE PAGE 17					

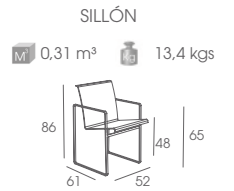

### BUTAQUE CHAIR

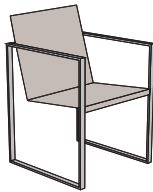

FRAME:		BRUSHED STAINLESS STEEL	ELECTRO POLISHED STAINLESS STEEL	POWDERCOATED STAINLESS STEEL WHITE	POWDERCOATED STAINLESS STEEL CENDRE	POWDERCOATED STAINLESS STEEL BLACK	TEAK
SEAT:							
BATYLINE®	WHITE	€ 690 BTQWU	€ 790 BTQEPWU	€ 790 BTQWRWU	-	-	€ 790 BTQTWU
	CENDRE	€ 690 BTQCE	€ 790 BTQEPCE	-	€ 790 BTQCCE	-	€ 790 BTQTCE
	BLACK	€ 690 BTQZU	€ 790 BTQEPZU	-	-	€ 790 BTQAZU	€ 790 BTQTZU
SEAT + BACK CUSHION		SLIM TEMPOTEST®   SUNBRELLA®/CAT.A € 80   € 140		STANDARD TEMPOTEST®   SUNBRELLA®/CAT.A € 220   € 260		SYNTHETIC LEATHER STAMSKIN® WITHOUT BUTTONS € 270	
		SYNTHETIC LEATHER STAMSKIN® WITH BUTTONS € 320					
FOR MORE INFORMATION ABOUT CUSHIONS SEE PAGE 17							

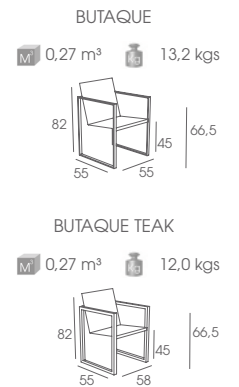

### POLTRONA EASY CHAIR



FRAME:		BRUSHED STAINLESS STEEL	ELECTRO POLISHED STAINLESS STEEL	POWDERCOATED STAINLESS STEEL WHITE	POWDERCOATED STAINLESS STEEL CENDRE	POWDERCOATED STAINLESS STEEL BLACK	TEAK
SEAT:							
BATYLINE®	WHITE	-	€ 1100 PTNEPWU	-	-	-	-
	CENDRE	-	€ 1100 PTNEPCE	-	-	-	-
	BLACK	-	€ 1100 PTNEPZU	-	-	-	-
SEAT + BACK CUSHION		SLIM TEMPOTEST®   SUNBRELLA®/CAT.A € 90   € 160 FOR MORE INFORMATION ABOUT CUSHIONS SEE PAGE 17					

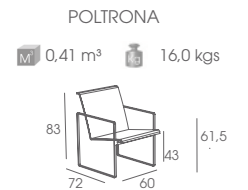

PRODUCT

PRICES & REFERENCES

SPECS

POLTRONA TRES  
SOFA

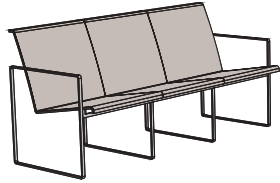

FRAME:	BRUSHED STAINLESS STEEL	ELECTRO POLISHED STAINLESS STEEL	POWDERCOATED STAINLESS STEEL WHITE	POWDERCOATED STAINLESS STEEL CENDRE	POWDERCOATED STAINLESS STEEL BLACK	TEAK
SEAT:						
BATYLINE® WHITE	-	€ 2.010 PTTEPWU	-	-	-	-
CENDRE	-	€ 2.010 PTTEPCE	-	-	-	-
BLACK	-	€ 2.010 PTTEPZU	-	-	-	-
SEAT + BACK CUSHION	SLIM TEMPOTEST®   SUNBRELLA®CAT.A € 240   € 480 FOR MORE INFORMATION ABOUT CUSHIONS SEE PAGE 18					

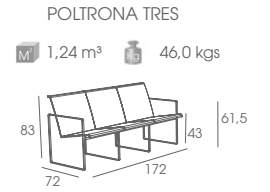

ESCABEL  
FOOTREST

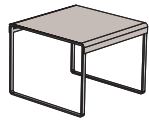

FRAME:	BRUSHED STAINLESS STEEL	ELECTRO POLISHED STAINLESS STEEL	POWDERCOATED STAINLESS STEEL WHITE	POWDERCOATED STAINLESS STEEL CENDRE	POWDERCOATED STAINLESS STEEL BLACK	TEAK
SEAT:						
BATYLINE® WHITE	-	€ 480 ESBEPWU	-	-	-	-
CENDRE	-	€ 480 ESBEPCE	-	-	-	-
BLACK	-	€ 480 ESBEPZU	-	-	-	-
SEAT + BACK CUSHION	SLIM TEMPOTEST®   SUNBRELLA®CAT.A € 60   € 105 FOR MORE INFORMATION ABOUT CUSHIONS SEE PAGE 18					



TUMBONA  
LOUNGER  
- FIXED POSITION

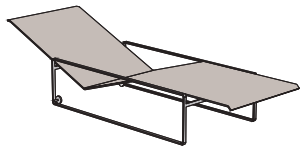

FRAME:	BRUSHED STAINLESS STEEL	ELECTRO POLISHED STAINLESS STEEL	POWDERCOATED STAINLESS STEEL WHITE	POWDERCOATED STAINLESS STEEL CENDRE	POWDERCOATED STAINLESS STEEL BLACK	TEAK
SEAT:						
BATYLINE® WHITE	-	€ 1.240 TBNEPWU	-	-	-	-
CENDRE	-	€ 1.240 TBNEPCE	-	-	-	-
BLACK	-	€ 1.240 TBNEPZU	-	-	-	-
SEAT + BACK CUSHION	SLIM TEMPOTEST®   SUNBRELLA®CAT.A € 270   € 480 FOR MORE INFORMATION ABOUT CUSHIONS SEE PAGE 18					

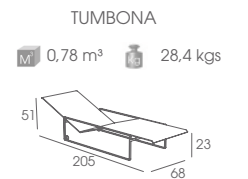

PRODUCT

PRICES & REFERENCES

SPECS

TABURETE  
BARSTOOL



FRAME:		BRUSHED STAINLESS STEEL	ELECTRO POLISHED STAINLESS STEEL	POWDERCOATED STAINLESS STEEL WHITE	POWDERCOATED STAINLESS STEEL CENDRE	POWDERCOATED STAINLESS STEEL BLACK	TEAK
SEAT:							
BATYLINE®							
WHITE		-	€ 880 TBREPWU	-	-	-	-
CENDRE		-	€ 880 TBREPCE	-	-	-	-
BLACK		-	€ 880 TBREPZU	-	-	-	-
SEAT + BACK CUSHION		SLIM TEMPOTEST®   SUNBRELLA®CAT.A € 80   € 150 FOR MORE INFORMATION ABOUT CUSHIONS SEE PAGE 18					

TABURETE  
M 0,21 m³ | 15,8 kgs

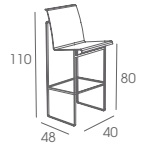

PEQUEÑA  
SIDE TABLE



BASE:		BRUSHED STAINLESS STEEL	ELECTRO POLISHED STAINLESS STEEL	POWDERCOATED STAINLESS STEEL WHITE	POWDERCOATED STAINLESS STEEL CENDRE	POWDERCOATED STAINLESS STEEL BLACK
TOP:						
GLASS 10 mm						
WHITE		-	€ 530 PQNGEPWU	-	-	-
CENDRE		-	€ 530 PQNGEPCLU	-	-	-
BLACK		-	€ 530 PQNGEPZU	-	-	-
CERAMIC 10 mm						
WHITE		-	€ 580 PQNCEPWU	-	-	-
CENDRE		-	€ 580 PQNCEPPG	-	-	-
BLACK		-	€ 580 PQNCEPZU	-	-	-
TEAK 20 mm						
TEAK		-	€ 440 PQNTEP	-	-	-
BLUESTONE 20 mm						
BLUESTONE		-	€ 580 PQNHEP	-	-	-

PEQUEÑA GLASS  
M 0,16 m³ | 11,2 kgs

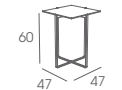

PEQUEÑA CERAMIC  
M 0,16 m³ | 11,2 kgs

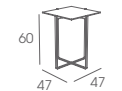

PEQUEÑA TEAK  
M 0,16 m³ | 10,2 kgs

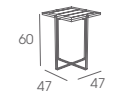

PEQUEÑA BLUESTONE  
M 0,16 m³ | 18,8 kgs

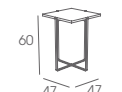

SPECIAL CERAMIC  
PRICE ON REQUEST (PAG 42)



PRODUCT

MESONA 50  
SIDE TABLE



SPECIAL CERAMIC  
PRICE ON REQUEST (PAG 42)



PRICES & REFERENCES

BASE:		BRUSHED STAINLESS STEEL	ELECTRO POLISHED STAINLESS STEEL	POWDERCOATED STAINLESS STEEL WHITE	POWDERCOATED STAINLESS STEEL CENDRE	POWDERCOATED STAINLESS STEEL BLACK
TOP:						
GLASS 10 mm	WHITE	-	€ 1.140 MSN50GEPWU	-	-	-
	CENDRE	-	€ 1.140 MSN50GEPCLU	-	-	-
	BLACK	-	€ 1.140 MSN50GEPZU	-	-	-
CERAMIC 10 mm	WHITE	-	€ 1.200 MSN50CEPWU	-	-	-
	CENDRE	-	€ 1.200 MSN50CEPPG	-	-	-
	BLACK	-	€ 1.200 MSN50CEPZU	-	-	-
TEAK 20 mm	TEAK	-	€ 1.060 MSN50TEP	-	-	-

SPECS

MESONA 50 GLASS  
M 0,15 m³ I 12,4 kgs

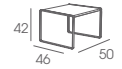

MESONA 50 CERAMIC  
M 0,15 m³ I 12,4 kgs

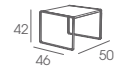

MESONA 50 TEAK  
M 0,15 m³ I 11,4 kgs

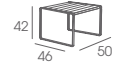

MESONA 142  
SALON TABLE

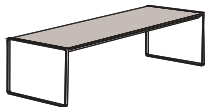

SPECIAL CERAMIC  
PRICE ON REQUEST (PAG 42)



BASE:		BRUSHED STAINLESS STEEL	ELECTRO POLISHED STAINLESS STEEL	POWDERCOATED STAINLESS STEEL WHITE	POWDERCOATED STAINLESS STEEL CENDRE	POWDERCOATED STAINLESS STEEL BLACK
TOP:						
GLASS 10 mm	WHITE	-	€ 1.800 MSN142GEPWU	-	-	-
	CENDRE	-	€ 1.800 MSN142GEPCLU	-	-	-
	BLACK	-	€ 1.800 MSN142GEPZU	-	-	-
CERAMIC 10 mm	WHITE	-	€ 2.000 MSN142CEPWU	-	-	-
	CENDRE	-	€ 2.000 MSN142CEPPG	-	-	-
	BLACK	-	€ 2.000 MSN142CEPZU	-	-	-
TEAK 20 mm	TEAK	-	€ 1.760 MSN142TEP	-	-	-

MESONA 142 GLASS  
M 0,41 m³ I 36,7 kgs

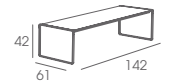

MESONA 142 CERAMIC  
M 0,41 m³ I 36,7 kgs

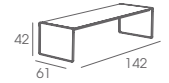

MESONA 142 TEAK  
M 0,41 m³ I 34,1 kgs

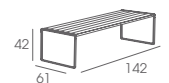

PRODUCT

NIMIO BAR 60  
HIGH TABLE



SPECIAL CERAMIC  
PRICE ON REQUEST (PAG 42)



BASE:		BRUSHED STAINLESS STEEL	ELECTRO POLISHED STAINLESS STEEL	POWDERCOATED STAINLESS STEEL WHITE	POWDERCOATED STAINLESS STEEL CENDRE	POWDERCOATED STAINLESS STEEL BLACK	
TOP:	GLASS 10 mm	WHITE	€ 1.490 NMB60GWU	€ 1.750 NMB60GEPWU	€ 1.750 NMB60GWRWU	€ 1.750 NMB60GCWU	€ 1.750 NMB60GAWU
		CENDRE	€ 1.490 NMB60GCLU	€ 1.750 NMB60GEPCLU	€ 1.750 NMB60GWRCLU	€ 1.750 NMB60GCCLU	€ 1.750 NMB60GACLU
		BLACK	€ 1.490 NMB60GZU	€ 1.750 NMB60GEPZU	€ 1.750 NMB60GWRZU	€ 1.750 NMB60GCZU	€ 1.750 NMB60GAZU
	CERAMIC 10 mm	WHITE	€ 1.650 NMB60CWU	€ 1.870 NMB60CEPWU	€ 1.870 NMB60CWRWU	€ 1.870 NMB60CCWU	€ 1.870 NMB60CAWU
		CENDRE	€ 1.650 NMB60CPG	€ 1.870 NMB60CEPCPG	€ 1.870 NMB60CWRPG	€ 1.870 NMB60CCPG	€ 1.870 NMB60CAPG
		BLACK	€ 1.650 NMB60CZU	€ 1.870 NMB60CEPZU	€ 1.870 NMB60CWRZU	€ 1.870 NMB60CCZU	€ 1.870 NMB60CAZU
	BLUESTONE 20 mm	BLUESTONE	€ 1.800 NMB60H	€ 2.000 NMB60HEP	€ 2.000 NMB60HWR	€ 2.000 NMB60HC	€ 2.000 NMB60HA

SPECS

NIMIO BAR 60 GLASS  
M<sup>3</sup> 0,39 m<sup>3</sup> Kgs 38,7 kgs

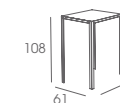

NIMIO BAR 60 CERAMIC  
M<sup>3</sup> 0,39 m<sup>3</sup> Kgs 38,7 kgs

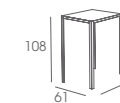

NIMIO BAR 60 BLUESTONE  
M<sup>3</sup> 0,39 m<sup>3</sup> Kgs 67,5 kgs

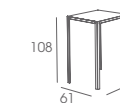

NIMIO BAR 140  
BAR TABLE

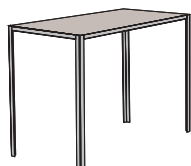

SPECIAL CERAMIC  
PRICE ON REQUEST (PAG 42)



BASE:		BRUSHED STAINLESS STEEL	ELECTRO POLISHED STAINLESS STEEL	POWDERCOATED STAINLESS STEEL WHITE	POWDERCOATED STAINLESS STEEL CENDRE	POWDERCOATED STAINLESS STEEL BLACK	
TOP:	GLASS 10 mm	WHITE	€ 1.970 NMB140GWU	€ 2.190 NMB140GEPWU	€ 2.190 NMB140GWRWU	€ 2.190 NMB140GCWU	€ 2.190 NMB140GAWU
		CENDRE	€ 1.970 NMB140GCLU	€ 2.190 NMB140GEPCLU	€ 2.190 NMB140GWRCLU	€ 2.190 NMB140GCCLU	€ 2.190 NMB140GACLU
		BLACK	€ 1.970 NMB140GZU	€ 2.190 NMB140GEPZU	€ 2.190 NMB140GWRZU	€ 2.190 NMB140GCZU	€ 2.190 NMB140GAZU
	CERAMIC 10 mm	WHITE	€ 2.410 NMB140CWU	€ 2.700 NMB140CEPWU	€ 2.700 NMB140CWRWU	€ 2.700 NMB140CCWU	€ 2.700 NMB140CAWU
		CENDRE	€ 2.410 NMB140CPG	€ 2.700 NMB140CEPPG	€ 2.700 NMB140CWRPG	€ 2.700 NMB140CCPG	€ 2.700 NMB140CAPG
		BLACK	€ 2.410 NMB140CZU	€ 2.700 NMB140CEPZU	€ 2.700 NMB140CWRZU	€ 2.700 NMB140CCZU	€ 2.700 NMB140CAZU
	TEAK 20 mm	TEAK	€ 1.930 NMB140T	€ 2.180 NMB140TEP	€ 2.180 NMB140TWR	€ 2.180 NMB140TC	€ 2.180 NMB140TA
		BLUESTONE 20 mm	€ 2.600 NMB140H	€ 2.800 NMB140HEP	€ 2.800 NMB140HWR	€ 2.800 NMB140HC	€ 2.800 NMB140HA

NIMIO BAR 140 GLASS  
M<sup>3</sup> 0,96 m<sup>3</sup> Kgs 43,2 kgs

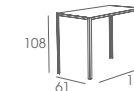

NIMIO BAR 140 CERAMIC  
M<sup>3</sup> 0,96 m<sup>3</sup> Kgs 43,2 kgs

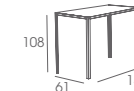

NIMIO BAR 140 TEAK  
M<sup>3</sup> 0,96 m<sup>3</sup> Kgs 40,3 kgs

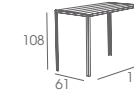

NIMIO BAR 140 BLUESTONE  
M<sup>3</sup> 1,02 m<sup>3</sup> Kgs 82,8 kgs

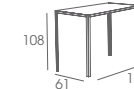



PRODUCT

PRICES & REFERENCES

SPECS

NIMIO BAR 190  
BAR TABLE

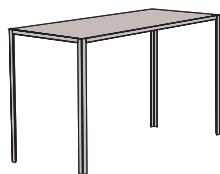

SPECIAL CERAMIC  
PRICE ON REQUEST (PAG 42)



BASE:		BRUSHED STAINLESS STEEL	ELECTRO POLISHED STAINLESS STEEL	POWDERCOATED STAINLESS STEEL WHITE	POWDERCOATED STAINLESS STEEL CENDRE	POWDERCOATED STAINLESS STEEL BLACK
TOP:	GLASS 10 mm					
	WHITE	€ 2.500 NMB190GWU	€ 2.800 NMB190GEPWU	€ 2.800 NMB190GWRWU	€ 2.800 NMB190GCWU	€ 2.800 NMB190GAWU
	CENDRE	€ 2.500 NMB190GCLU	€ 2.800 NMB190GEPCLU	€ 2.800 NMB190GWRCLU	€ 2.800 NMB190GCCLU	€ 2.800 NMB190GACLU
	BLACK	€ 2.500 NMB190GZU	€ 2.800 NMB190GEPZU	€ 2.800 NMB190GWRZU	€ 2.800 NMB190GCZU	€ 2.800 NMB190GAZU
	CERAMIC 10 mm					
	WHITE	€ 3.100 NMB190CWU	€ 3.500 NMB190CEPWU	€ 3.500 NMB190CWRWU	€ 3.500 NMB190CCWU	€ 3.500 NMB190CAWU
	CENDRE	€ 3.100 NMB190CPG	€ 3.500 NMB190CEPPG	€ 3.500 NMB190CWRPG	€ 3.500 NMB190CCPG	€ 3.500 NMB190CAPG
	BLACK	€ 3.100 NMB190CZU	€ 3.500 NMB190CEPZU	€ 3.500 NMB190CWRZU	€ 3.500 NMB190CCZU	€ 3.500 NMB190CAZU
	TEAK 20 mm					
	TEAK	€ 2.400 NMB190T	€ 2.700 NMB190TEP	€ 2.700 NMB190TWR	€ 2.700 NMB190TC	€ 2.700 NMB190TA
	BLUESTONE 20 mm					
	BLUESTONE	€ 3.300 NMB190H	€ 3.500 NMB190HEP	€ 3.500 NMB190HWR	€ 3.500 NMB190HC	€ 3.500 NMB190HA

NIMIO BAR 190 GLASS

M 1,32 m³ K 56,6 kgs

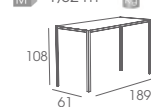

NIMIO BAR 190 CERAMIC

M 1,32 m³ K 56,6 kgs

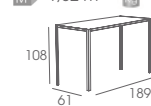

NIMIO BAR 190 TEAK

M 1,32 m³ K 53,4 kgs

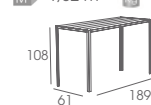

NIMIO BAR 190 BLUESTONE

M 1,42 m³ K 106,5 kgs

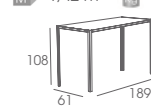

NIMIO 100  
TABLE

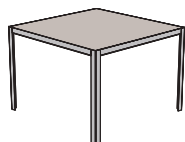

SPECIAL CERAMIC  
PRICE ON REQUEST (PAG 42)



BASE:		BRUSHED STAINLESS STEEL	ELECTRO POLISHED STAINLESS STEEL	POWDERCOATED STAINLESS STEEL WHITE	POWDERCOATED STAINLESS STEEL CENDRE	POWDERCOATED STAINLESS STEEL BLACK
TOP:	GLASS 10 mm					
	WHITE	€ 2.370 NMO100GWU	€ 2.640 NMO100GEPWU	€ 2.640 NMO100GWRWU	€ 2.640 NMO100GCWU	€ 2.640 NMO100GAWU
	CENDRE	€ 2.370 NMO100GCLU	€ 2.640 NMO100GEPCLU	€ 2.640 NMO100GWRCLU	€ 2.640 NMO100GCCLU	€ 2.640 NMO100GACLU
	BLACK	€ 2.370 NMO100GZU	€ 2.640 NMO100GEPZU	€ 2.640 NMO100GWRZU	€ 2.640 NMO100GCZU	€ 2.640 NMO100GAZU
	CERAMIC 10 mm					
	WHITE	€ 2.620 NMO100CWU	€ 2.750 NMO100CEPWU	€ 2.750 NMO100CWRWU	€ 2.750 NMO100CCWU	€ 2.750 NMO100CAWU
	CENDRE	€ 2.620 NMO100CPG	€ 2.750 NMO100CEPPG	€ 2.750 NMO100CWRPG	€ 2.750 NMO100CCPG	€ 2.750 NMO100CAPG
	BLACK	€ 2.620 NMO100CZU	€ 2.750 NMO100CEPZU	€ 2.750 NMO100CWRZU	€ 2.750 NMO100CCZU	€ 2.750 NMO100CAZU
	BLUESTONE 20 mm					
	BLUESTONE	€ 2.800 NMO100H	€ 3.000 NMO100HEP	€ 3.000 NMO100HWR	€ 3.000 NMO100HC	€ 3.000 NMO100HA

NIMIO 100 GLASS

M 0,77 m³ K 79,6 kgs

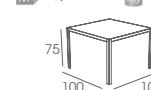

NIMIO 100 CERAMIC

M 0,77 m³ K 79,6 kgs



NIMIO 100 BLUESTONE

M 0,89 m³ K 137,4 kgs



PRODUCT

NIMIO 140  
TABLE

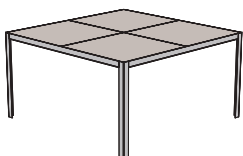

SPECIAL CERAMIC  
PRICE ON REQUEST (PAG 42)



PRICES & REFERENCES

TOP:	BASE:	BRUSHED STAINLESS STEEL	ELECTRO POLISHED STAINLESS STEEL	POWDERCOATED STAINLESS STEEL WHITE	POWDERCOATED STAINLESS STEEL CENDRE	POWDERCOATED STAINLESS STEEL BLACK
GLASS 10 mm	WHITE	€ 2.740 NMO140GWU	€ 2.950 NMO140GEPWU	€ 2.950 NMO140GWRWU	€ 2.950 NMO140GCWU	€ 2.950 NMO140GAWU
	CENDRE	€ 2.740 NMO140GCLU	€ 2.950 NMO140GEPCLU	€ 2.950 NMO140GWRCLU	€ 2.950 NMO140GCCLU	€ 2.950 NMO140GACLU
	BLACK	€ 2.740 NMO140GZU	€ 2.950 NMO140GEPZU	€ 2.950 NMO140GWRZU	€ 2.950 NMO140GCZU	€ 2.950 NMO140GAZU
CERAMIC 10 mm	WHITE	€ 3.880 NMO140CWU	€ 4.040 NMO140CEPWU	€ 4.040 NMO140CWRWU	€ 4.040 NMO140CCWU	€ 4.040 NMO140CAWU
	CENDRE	€ 3.880 NMO140CPG	€ 4.040 NMO140CEPPG	€ 4.040 NMO140CWRPG	€ 4.040 NMO140CCPG	€ 4.040 NMO140CAPG
	BLACK	€ 3.880 NMO140CZU	€ 4.040 NMO140CEPZU	€ 4.040 NMO140CWRZU	€ 4.040 NMO140CCZU	€ 4.040 NMO140CAZU
TEAK 20 mm	TEAK	€ 3.200 NMO140T	€ 3.500 NMO140TEP	€ 3.500 NMO140TWR	€ 3.500 NMO140TC	€ 3.500 NMO140TA
BLUESTONE 20 mm	BLUESTONE	€ 4.000 NMO140H	€ 4.200 NMO140HEP	€ 4.200 NMO140HWR	€ 4.200 NMO140HC	€ 4.200 NMO140HA

SPECS

NIMIO 140 GLASS  
M 1,69 m³ 99,5 kgs

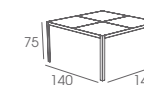

NIMIO 140 CERAMIC  
M 1,69 m³ 99,5 kgs

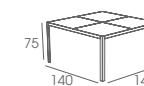

NIMIO 140 TEAK  
M 1,69 m³ 82,3 kgs

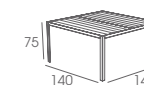

NIMIO 140 BLUESTONE  
M 1,69 m³ 174,0 kgs

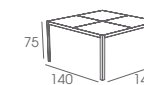

NIMIO 200  
TABLE

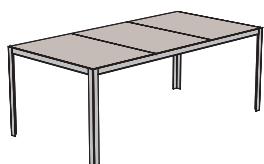

SPECIAL CERAMIC  
PRICE ON REQUEST (PAG 42)



TOP:	BASE:	BRUSHED STAINLESS STEEL	ELECTRO POLISHED STAINLESS STEEL	POWDERCOATED STAINLESS STEEL WHITE	POWDERCOATED STAINLESS STEEL CENDRE	POWDERCOATED STAINLESS STEEL BLACK
GLASS 10 mm	WHITE	€ 3.110 NMO200GWU	€ 3.500 NMO200GEPWU	€ 3.500 NMO200GWRWU	€ 3.500 NMO200GCWU	€ 3.500 NMO200GAWU
	CENDRE	€ 3.110 NMO200GCLU	€ 3.500 NMO200GEPCLU	€ 3.500 NMO200GWRCLU	€ 3.500 NMO200GCCLU	€ 3.500 NMO200GACLU
	BLACK	€ 3.110 NMO200GZU	€ 3.500 NMO200GEPZU	€ 3.500 NMO200GWRZU	€ 3.500 NMO200GCZU	€ 3.500 NMO200GAZU
CERAMIC 10 mm	WHITE	€ 3.400 NMO200CWU	€ 3.790 NMO200CEPWU	€ 3.790 NMO200CWRWU	€ 3.790 NMO200CCWU	€ 3.790 NMO200CAWU
	CENDRE	€ 3.400 NMO200CPG	€ 3.790 NMO200CEPPG	€ 3.790 NMO200CWRPG	€ 3.790 NMO200CCPG	€ 3.790 NMO200CAPG
	BLACK	€ 3.400 NMO200CZU	€ 3.790 NMO200CEPZU	€ 3.790 NMO200CWRZU	€ 3.790 NMO200CCZU	€ 3.790 NMO200CAZU
TEAK 20 mm	TEAK	€ 2.800 NMO200T	€ 3.190 NMO200TEP	€ 3.190 NMO200TWR	€ 3.190 NMO200TC	€ 3.190 NMO200TA
BLUESTONE 20 mm	BLUESTONE	€ 3.600 NMO200H	€ 3.900 NMO200HEP	€ 3.900 NMO200HWR	€ 3.900 NMO200HC	€ 3.900 NMO200HA

NIMIO 200 GLASS  
M 1,70 m³ 90,8 kgs

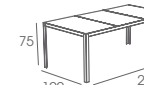

NIMIO 200 CERAMIC  
M 1,70 m³ 90,8 kgs

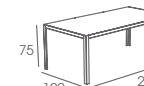

NIMIO 200 TEAK  
M 1,70 m³ 81,7 kgs

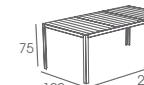

NIMIO 200 BLUESTONE  
M 1,70 m³ 183,9 kgs

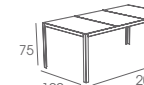

PRODUCT

NIMIO 260  
TABLE

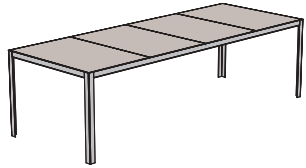

SPECIAL CERAMIC  
PRICE ON REQUEST (PAG 42)



PRICES & REFERENCES

TOP:	BASE:	BRUSHED STAINLESS STEEL	ELECTRO POLISHED STAINLESS STEEL	POWDERCOATED STAINLESS STEEL WHITE	POWDERCOATED STAINLESS STEEL CENDRE	POWDERCOATED STAINLESS STEEL BLACK
GLASS 10 mm	WHITE	€ 4.100 NMO260GWU	€ 4.400 NMO260GEPWU	€ 4.400 NMO260GWR	€ 4.400 NMO260GCWU	€ 4.400 NMO260GAWU
	CENDRE	€ 4.100 NMO260GCLU	€ 4.400 NMO260GEPCLU	€ 4.400 NMO260GWRCLU	€ 4.400 NMO260GCCLU	€ 4.400 NMO260GACLU
	BLACK	€ 4.100 NMO260GZU	€ 4.400 NMO260GEPZU	€ 4.400 NMO260GWRZU	€ 4.400 NMO260GCZU	€ 4.400 NMO260GAZU
CERAMIC 10 mm	WHITE	€ 4.800 NMO260CWU	€ 5.200 NMO260CEPWU	€ 5.200 NMO260CWRWU	€ 5.200 NMO260CCWU	€ 5.200 NMO260CAWU
	CENDRE	€ 4.800 NMO260CPG	€ 5.200 NMO260CEPPG	€ 5.200 NMO260CWRPG	€ 5.200 NMO260CCPG	€ 5.200 NMO260CAPG
	BLACK	€ 4.800 NMO260CZU	€ 5.200 NMO260CEPZU	€ 5.200 NMO260CWRZU	€ 5.200 NMO260CCZU	€ 5.200 NMO260CAZU
TEAK 20 mm	TEAK	€ 3.800 NMO260T	€ 4.100 NMO260TEP	€ 4.100 NMO260TWR	€ 4.100 NMO260TC	€ 4.100 NMO260TA
BLUESTONE 20 mm	BLUESTONE	€ 5.100 NMO260H	€ 5.400 NMO260HEP	€ 5.400 NMO260HWR	€ 5.400 NMO260HC	€ 5.400 NMO260HA

SPECS

NIMIO 260 GLASS  
M 2,26 m³ 122,7 kgs

NIMIO 260 CERAMIC  
M 2,26 m³ 122,7 kgs

NIMIO 260 TEAK  
M 2,26 m³ 110,5 kgs

NIMIO 260 BLUESTONE  
M 2,26 m³ 231,2 kgs

NIMIO 325  
TABLE

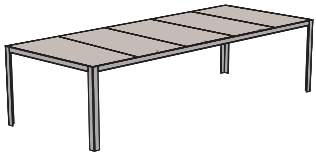

SPECIAL CERAMIC  
PRICE ON REQUEST (PAG 42)



TOP:	BASE:	BRUSHED STAINLESS STEEL	ELECTRO POLISHED STAINLESS STEEL	POWDERCOATED STAINLESS STEEL WHITE	POWDERCOATED STAINLESS STEEL CENDRE	POWDERCOATED STAINLESS STEEL BLACK
GLASS 10 mm	WHITE	€ 5.100 NMO325GWU	€ 5.400 NMO325GEPWU	€ 5.400 NMO325GWRWU	€ 5.400 NMO325GCWU	€ 5.400 NMO325GAWU
	CENDRE	€ 5.100 NMO325GCLU	€ 5.400 NMO325GEPCLU	€ 5.400 NMO325GWRCLU	€ 5.400 NMO325GCCLU	€ 5.400 NMO325GACLU
	BLACK	€ 5.100 NMO325GZU	€ 5.400 NMO325GEPZU	€ 5.400 NMO325GWRZU	€ 5.400 NMO325GCZU	€ 5.400 NMO325GAZU
CERAMIC 10 mm	WHITE	€ 5.800 NMO325CWU	€ 6.400 NMO325CEPWU	€ 6.400 NMO325CWRWU	€ 6.400 NMO325CCWU	€ 6.400 NMO325CAWU
	CENDRE	€ 5.800 NMO325CPG	€ 6.400 NMO325CEPPG	€ 6.400 NMO325CWRPG	€ 6.400 NMO325CCPG	€ 6.400 NMO325CAPG
	BLACK	€ 5.800 NMO325CZU	€ 6.400 NMO325CEPZU	€ 6.400 NMO325CWRZU	€ 6.400 NMO325CCZU	€ 6.400 NMO325CAZU
TEAK 20 mm	TEAK	€ 4.500 NMO325T	€ 5.100 NMO325TEP	€ 5.100 NMO325TWR	€ 5.100 NMO325TC	€ 5.100 NMO325TA

NIMIO 325 GLASS  
M 1,70 m³ 90,8 kgs

NIMIO 325 CERAMIC  
M 1,70 m³ 90,8 kgs

NIMIO 325 TEAK  
M 1,70 m³ 81,7 kgs

PRODUCT

SINGULAR 80  
BISTRO TABLE

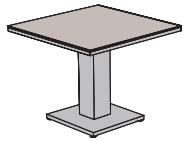

SPECIAL CERAMIC  
PRICE ON REQUEST (PAG 42)



PRICES & REFERENCES

BASE:		BRUSHED STAINLESS STEEL	ELECTRO POLISHED STAINLESS STEEL	POWDERCOATED STAINLESS STEEL WHITE	POWDERCOATED STAINLESS STEEL CENDRE	POWDERCOATED STAINLESS STEEL BLACK	
TOP:							
GLASS 10 mm	WHITE	€ 1.920 SNG80GWU	€ 2.300 SNG80GEPWU	€ 2.300 SNG80GWRWU	-	-	
	CENDRE	€ 1.920 SNG80GCLU	€ 2.300 SNG80GEPCLU	-	€ 2.300 SNG80GCCLU	-	
	BLACK	€ 1.920 SNG80GZU	€ 2.300 SNG80GEPZU	-	-	€ 2.300 SNG80GAZU	
	CERAMIC 10 mm	WHITE	€ 2.280 SNG80CWU	€ 2.660 SNG80CEPWU	€ 2.660 SNG80CWRWU	-	-
		CENDRE	€ 2.280 SNG80CPG	€ 2.660 SNG80CEPPG	-	€ 2.660 SNG80CCPG	-
		BLACK	€ 2.280 SNG80CZU	€ 2.660 SNG80CEPZU	-	-	€ 2.660 SNG80CAZU
TEAK 40 mm	TEAK	€ 1.920 SNG80T	€ 2.300 SNG80TEP	€ 2.300 SNG80TWR	€ 2.300 SNG80TC	€ 2.300 SNG80TA	

SPECS

SINGULAR 80 GLASS  
M 0,27 m³ W 42,2 kgs

SINGULAR 80 CERAMIC  
M 0,27 m³ W 42,2 kgs

SINGULAR 80 TEAK  
M 0,24 m³ W 35,0 kgs

SINGULAR 90  
BISTRO TABLE

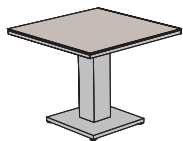

SPECIAL CERAMIC  
PRICE ON REQUEST (PAG 42)



BASE:		BRUSHED STAINLESS STEEL	ELECTRO POLISHED STAINLESS STEEL	POWDERCOATED STAINLESS STEEL WHITE	POWDERCOATED STAINLESS STEEL CENDRE	POWDERCOATED STAINLESS STEEL BLACK
TOP:						
GLASS 10 mm	WHITE	€ 2.040 SNG90GWU	€ 2.510 SNG90GEPWU	€ 2.510 SNG90GWRWU	-	-
	CENDRE	€ 2.040 SNG90GCLU	€ 2.510 SNG90GEPCLU	-	€ 2.510 SNG90GCCLU	-
	BLACK	€ 2.040 SNG90GZU	€ 2.510 SNG90GEPZU	-	-	€ 2.510 SNG90GAZU
CERAMIC 10 mm	WHITE	€ 2.360 SNG90CWU	€ 2.830 SNG90CEPWU	€ 2.830 SNG90CWRWU	-	-
	CENDRE	€ 2.360 SNG90CPG	€ 2.830 SNG90CEPPG	-	€ 2.830 SNG90CCPG	-
	BLACK	€ 2.360 SNG90CZU	€ 2.830 SNG90CEPZU	-	-	€ 2.830 SNG90GAZU
TEAK 40 mm	TEAK	€ 2.040 SNG90T	€ 2.510 SNG90TEP	€ 2.510 SNG90TWR	€ 2.510 SNG90TC	€ 2.510 SNG90TA

SINGULAR 90 GLASS  
M 0,28 m³ W 48,0 kgs

SINGULAR 90 CERAMIC  
M 0,28 m³ W 48,0 kgs

SINGULAR 90 TEAK  
M 0,28 m³ W 40,0 kgs

PRODUCT

DOBLE BENCH 160  
BENCH

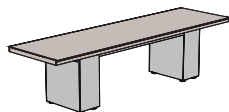

PRICES & REFERENCES

BASE:		BRUSHED STAINLESS STEEL	ELECTRO POLISHED STAINLESS STEEL	POWDERCOATED STAINLESS STEEL WHITE	POWDERCOATED STAINLESS STEEL CENDRE	POWDERCOATED STAINLESS STEEL BLACK
SEAT:						
BATYLINE®		€ 1.970 DBB160WU	€ 2.130 DBB160EPWU	€ 2.130 DBB160WRWU	-	-
	WHITE					
	CENDRE	€ 1.970 DBB160CE	€ 2.130 DBB160EPCE	-	€ 2.130 DBB160CCE	-
	BLACK	€ 1.970 DBB160ZU	€ 2.130 DBB160EPZU	-	-	€ 2.130 DBB160AZU
TEAK		€ 1.480 DBB160T	€ 1.640 DBB160TEP	€ 1.640 DBB160TWR	€ 1.640 DBB160TC	€ 1.640 DBB160TA
CUSHION		SLIM TEMPOTEST®   SUNBRELLA®@CAT.A € 95   € 160		STANDARD TEMPOTEST®   SUNBRELLA®@CAT.A € 315   € 360		SYNTHETIC LEATHER STAMSKIN® WITHOUT BUTTONS € 380
				SYNTHETIC LEATHER STAMSKIN® WITH BUTTONS € 430		

FOR MORE INFORMATION ABOUT CUSHIONS SEE PAGE 19

SPECS

DOBLE BENCH 160

M 0,22 m³ | 37,4 kgs

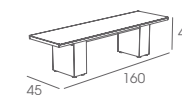

DOBLE BENCH 160 TEAK

M 0,22 m³ | 31,2 kgs

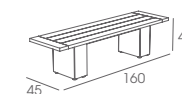

DOBLE BENCH 240  
BENCH

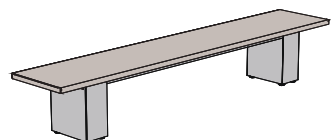

BASE:		BRUSHED STAINLESS STEEL	ELECTRO POLISHED STAINLESS STEEL	POWDERCOATED STAINLESS STEEL WHITE	POWDERCOATED STAINLESS STEEL CENDRE	POWDERCOATED STAINLESS STEEL BLACK
SEAT:						
BATYLINE®		€ 2.430 DBB240WU	€ 2.630 DBB240EPWU	€ 2.630 DBB240WRWU	-	-
	WHITE					
	CENDRE	€ 2.430 DBB240CE	€ 2.630 DBB240EPCE	-	€ 2.630 DBB240CCE	-
	BLACK	€ 2.430 DBB240ZU	€ 2.630 DBB240EPZU	-	-	€ 2.630 DBB240AZU
TEAK		€ 1.880 DBB240T	€ 2.090 DBB240TEP	€ 2.090 DBB240TWR	€ 2.090 DBB240TC	€ 2.090 DBB240TA
CUSHION		SLIM TEMPOTEST®   SUNBRELLA®@CAT.A € 130   € 240		STANDARD TEMPOTEST®   SUNBRELLA®@CAT.A € 340   € 390		SYNTHETIC LEATHER STAMSKIN® WITHOUT BUTTONS € 550
				SYNTHETIC LEATHER STAMSKIN® WITH BUTTONS € 595		

FOR MORE INFORMATION ABOUT CUSHIONS SEE PAGE 19

DOBLE BENCH 240

M 0,36 m³ | 48,0 kgs

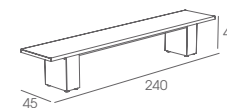

DOBLE BENCH 240 TEAK

M 0,36 m³ | 40,4 kgs

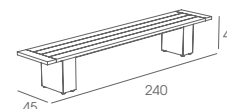

PRODUCT

DOBLE 160  
TABLE

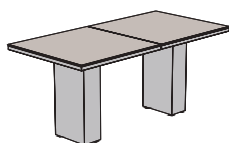

SPECIAL CERAMIC  
PRICE ON REQUEST (PAG 42)



PRICES & REFERENCES

TOP:	BASE:	BRUSHED STAINLESS STEEL	ELECTRO POLISHED STAINLESS STEEL	POWDERCOATED STAINLESS STEEL WHITE	POWDERCOATED STAINLESS STEEL CENDRE	POWDERCOATED STAINLESS STEEL BLACK
GLASS 10 mm	WHITE	€ 2.800 DBL160GWU	€ 3.100 DBL160GEPWU	€ 3.100 DBL160GWRWU	€ 3.100 DBL160GCWU	€ 3.100 DBL160GAWU
	CENDRE	€ 2.800 DBL160GCLU	€ 3.100 DBL160GEPCLU	€ 3.100 DBL160GWRCLU	€ 3.100 DBL160GCCLU	€ 3.100 DBL160GACLU
	BLACK	€ 2.800 DBL160GZU	€ 3.100 DBL160GEPZU	€ 3.100 DBL160GWRZU	€ 3.100 DBL160GCZU	€ 3.100 DBL160GAZU
CERAMIC 10 mm	WHITE	€ 3.420 DBL160CWU	€ 3.730 DBL160CEPWU	€ 3.730 DBL160CWRWU	€ 3.730 DBL160CCWU	€ 3.730 DBL160CAWU
	CENDRE	€ 3.420 DBL160CPG	€ 3.730 DBL160CEPPG	€ 3.730 DBL160CWRPG	€ 3.730 DBL160CCPG	€ 3.730 DBL160CAPG
	BLACK	€ 3.420 DBL160CZU	€ 3.730 DBL160CEPZU	€ 3.730 DBL160CWRZU	€ 3.730 DBL160CCZU	€ 3.730 DBL160CAZU
TEAK 40 mm	TEAK	€ 2.650 DBL160T	€ 3.040 DBL160TEP	€ 3.040 DBL160TWR	€ 3.040 DBL160TC	€ 3.040 DBL160TA
	BLUESTONE 40 mm BLUESTONE	€ 3.600 DBL160H	€ 3.800 DBL160HEP	€ 3.800 DBL160HWR	€ 3.800 DBL160HC	€ 3.800 DBL160HA

SPECS

DOBLE 160 GLASS  
M<sup>3</sup> 0,45 m<sup>3</sup> 83,1 kgs

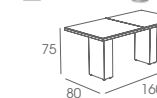

DOBLE 160 CERAMIC  
M<sup>3</sup>

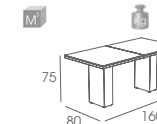

DOBLE 160 TEAK  
M<sup>3</sup> 0,36 m<sup>3</sup> 68,7 kgs

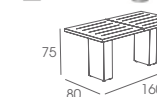

DOBLE 160 BLUESTONE  
M<sup>3</sup> 0,52 m<sup>3</sup> 191,7 kgs

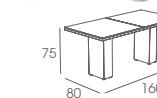

DOBLE 180  
TABLE

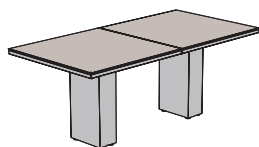

SPECIAL CERAMIC  
PRICE ON REQUEST (PAG 42)



TOP:	BASE:	BRUSHED STAINLESS STEEL	ELECTRO POLISHED STAINLESS STEEL	POWDERCOATED STAINLESS STEEL WHITE	POWDERCOATED STAINLESS STEEL CENDRE	POWDERCOATED STAINLESS STEEL BLACK
GLASS 10 mm	WHITE	€ 3.200 DBL180GWU	€ 3.600 DBL180GEPWU	€ 3.600 DBL180GWRWU	€ 3.600 DBL180GCWU	€ 3.600 DBL180GAWU
	CENDRE	€ 3.200 DBL180GCLU	€ 3.600 DBL180GEPCLU	€ 3.600 DBL180GWRCLU	€ 3.600 DBL180GCCLU	€ 3.600 DBL180GACLU
	BLACK	€ 3.200 DBL180GZU	€ 3.600 DBL180GEPZU	€ 3.600 DBL180GWRZU	€ 3.600 DBL180GCZU	€ 3.600 DBL180GAZU
CERAMIC 10 mm	WHITE	€ 3.900 DBL180CWU	€ 4.200 DBL180CEPWU	€ 4.200 DBL180CWRWU	€ 4.200 DBL180CCWU	€ 4.200 DBL180CAWU
	CENDRE	€ 3.900 DBL180CPG	€ 4.200 DBL180CEPPG	€ 4.200 DBL180CWRPG	€ 4.200 DBL180CCPG	€ 4.200 DBL180CAPG
	BLACK	€ 3.900 DBL180CZU	€ 4.200 DBL180CEPZU	€ 4.200 DBL180CWRZU	€ 4.200 DBL180CCZU	€ 4.200 DBL180CAZU
TEAK 40 mm	TEAK	€ 3.100 DBL180T	€ 3.500 DBL180TEP	€ 3.500 DBL180TWR	€ 3.500 DBL180TC	€ 3.500 DBL180TA
	BLUESTONE 40 mm BLUESTONE	€ 4.100 DBL180H	€ 4.400 DBL180HEP	€ 4.400 DBL180HWR	€ 4.400 DBL180HC	€ 4.400 DBL180HA

DOBLE 180 GLASS  
M<sup>3</sup> 0,46 m<sup>3</sup> 94,8 kgs

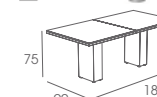

DOBLE 180 CERAMIC  
M<sup>3</sup> 0,46 m<sup>3</sup> 94,8 kgs

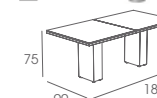

DOBLE 180 TEAK  
M<sup>3</sup> 0,38 m<sup>3</sup> 78,8 kgs



DOBLE 180 BLUESTONE  
M<sup>3</sup> 0,57 m<sup>3</sup> 227,8 kgs

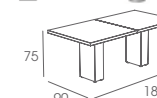

PRODUCT

DOBLE 240  
TABLE

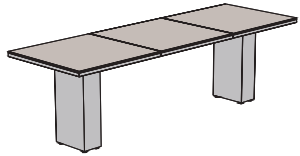

SPECIAL CERAMIC  
PRICE ON REQUEST (PAG 42)



PRICES & REFERENCES

BASE:		BRUSHED STAINLESS STEEL	ELECTRO POLISHED STAINLESS STEEL	POWDERCOATED STAINLESS STEEL WHITE	POWDERCOATED STAINLESS STEEL CENDRE	POWDERCOATED STAINLESS STEEL BLACK
TOP:	GLASS 10 mm					
	WHITE	€ 3.850 DBL240GWU	€ 4.150 DBL240GEPWU	€ 4.150 DBL240GWRWU	€ 4.150 DBL240GCWU	€ 4.150 DBL240GAWU
	CENDRE	€ 3.850 DBL240GCLU	€ 4.150 DBL240GEPCLU	€ 4.150 DBL240GWRCLU	€ 4.150 DBL240GCCLU	€ 4.150 DBL240GACLU
	BLACK	€ 3.850 DBL240GZU	€ 4.150 DBL240GEPZU	€ 4.150 DBL240GWRZU	€ 4.150 DBL240GCZU	€ 4.150 DBL240GAZU
	CERAMIC 10 mm					
	WHITE	€ 4.780 DBL240CWU	€ 5.190 DBL240CEPWU	€ 5.190 DBL240CWRWU	€ 5.190 DBL240CCWU	€ 5.190 DBL240CAWU
	CENDRE	€ 4.780 DBL240CPG	€ 5.190 DBL240CEPPG	€ 5.190 DBL240CWRPG	€ 5.190 DBL240CCPG	€ 5.190 DBL240CAPG
	BLACK	€ 4.780 DBL240CZU	€ 5.190 DBL240CEPZU	€ 5.190 DBL240CWRZU	€ 5.190 DBL240CCZU	€ 5.190 DBL240CAZU
	TEAK 40 mm					
	TEAK	€ 3.850 DBL240T	€ 4.150 DBL240TEP	€ 4.150 DBL240TWR	€ 4.150 DBL240TC	€ 4.150 DBL240TA
	BLUESTONE 40 mm					
	BLUESTONE	€ 5.100 DBL240H	€ 5.400 DBL240HEP	€ 5.400 DBL240HWR	€ 5.400 DBL240HC	€ 5.400 DBL240HA

SPECS

DOBLE 240 GLASS  
M 0,75 m³ 112,9 kgs

DOBLE 240 CERAMIC  
M 0,75 m³ 112,9 kgs

DOBLE 240 TEAK  
M 0,63 m³ 91,3 kgs

DOBLE 240 BLUESTONE  
M 0,79 m³ 264,3 kgs

DOBLE 240N  
TABLE

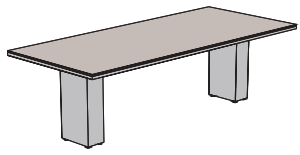

SPECIAL CERAMIC  
PRICE ON REQUEST (PAG 42)



BASE:		BRUSHED STAINLESS STEEL	ELECTRO POLISHED STAINLESS STEEL	POWDERCOATED STAINLESS STEEL WHITE	POWDERCOATED STAINLESS STEEL CENDRE	POWDERCOATED STAINLESS STEEL BLACK
TOP:	GLASS 10 mm					
	WHITE	€ 4.550 DBL240NGWU	€ 5.160 DBL240NGEPWU	€ 5.160 DBL240NGWRWU	€ 5.160 DBL240NGCWU	€ 5.160 DBL240NGAWU
	CENDRE	€ 4.550 DBL240NGCLU	€ 5.160 DBL240NGEPCLU	€ 5.160 DBL240NGWRCLU	€ 5.160 DBL240NGCCLU	€ 5.160 DBL240NGACLU
	BLACK	€ 4.550 DBL240NGZU	€ 5.160 DBL240NGEPZU	€ 5.160 DBL240NGWRZU	€ 5.160 DBL240NGCZU	€ 5.160 DBL240NGAZU
	CERAMIC 10 mm					
	WHITE	€ 5.350 DBL240NCWU	€ 5.800 DBL240NCEPWU	€ 5.800 DBL240NCWRWU	€ 5.800 DBL240NCCWU	€ 5.800 DBL240NCAWU
	CENDRE	€ 5.350 DBL240NCPG	€ 5.800 DBL240NCEPPG	€ 5.800 DBL240NCWRPG	€ 5.800 DBL240NCCPG	€ 5.800 DBL240NCAPG
	BLACK	€ 5.350 DBL240NCZU	€ 5.800 DBL240NCEPZU	€ 5.800 DBL240NCWRZU	€ 5.800 DBL240NCCZU	€ 5.800 DBL240NCAZU
	TEAK 40 mm					
	TEAK	€ 4.550 DBL240NT	€ 5.160 DBL240NTEP	€ 5.160 DBL240NTWR	€ 5.160 DBL240NTC	€ 5.160 DBL240NTA

DOBLE 240N GLASS  
M 0,46 m³ 94,8 kgs

DOBLE 240N CERAMIC  
M 0,46 m³ 94,8 kgs

DOBLE 240N TEAK  
M 0,38 m³ 78,8 kgs

PRODUCT

DOBLE 270  
TABLE

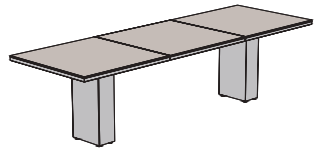

SPECIAL CERAMIC  
PRICE ON REQUEST (PAG 42)



PRICES & REFERENCES

BASE:		BRUSHED STAINLESS STEEL	ELECTRO POLISHED STAINLESS STEEL	POWDERCOATED STAINLESS STEEL WHITE	POWDERCOATED STAINLESS STEEL CENDRE	POWDERCOATED STAINLESS STEEL BLACK
TOP:						
GLASS 10 mm						
	WHITE	€ 4.550 DBL270GWU	€ 5.160 DBL270GEPWU	€ 5.160 DBL270GWRWU	€ 5.160 DBL270GCWU	€ 5.160 DBL270GAWU
	CENDRE	€ 4.550 DBL270GCLU	€ 5.160 DBL270GEPCLU	€ 5.160 DBL270GWRCLU	€ 5.160 DBL270GCCLU	€ 5.160 DBL270GACLU
	BLACK	€ 4.550 DBL270GZU	€ 5.160 DBL270GEPZU	€ 5.160 DBL270GWRZU	€ 5.160 DBL270GCZU	€ 5.160 DBL270GAZU
CERAMIC 10 mm						
	WHITE	€ 5.350 DBL270CWU	€ 5.800 DBL270CEPWU	€ 5.800 DBL270CWRWU	€ 5.800 DBL270CCWU	€ 5.800 DBL270CAWU
	CENDRE	€ 5.350 DBL270CPG	€ 5.800 DBL270CEPPG	€ 5.800 DBL270CWRPG	€ 5.800 DBL270CCPG	€ 5.800 DBL270CAPG
	BLACK	€ 5.350 DBL270CZU	€ 5.800 DBL2700CEPZU	€ 5.800 DBL270CWRZU	€ 5.800 DBL270CCZU	€ 5.800 DBL270CAZU
TEAK 40 mm						
	TEAK	€ 4.550 DBL270T	€ 5.160 DBL270TEP	€ 5.160 DBL270TWR	€ 5.160 DBL270TC	€ 5.160 DBL270TA
BLUESTONE 40 mm						
	BLUESTONE	€ 5.600 DBL270H	€ 6.100 DBL270HEP	€ 6.100 DBL270HWR	€ 6.100 DBL270HC	€ 6.100 DBL270HA

SPECS

DOBLE 270 GLASS  
M 0,78 m³ I 130,6 kgs

DOBLE 270 CERAMIC  
M 0,78 m³ I 130,6 kgs

DOBLE 270 TEAK  
M 0,66 m³ I 106,6 kgs

DOBLE 270 BLUESTONE  
M 0,86 m³ I 321,6 kgs

DOBLE 300  
TABLE

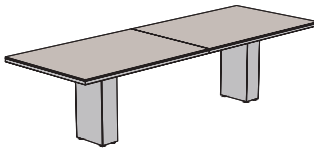

SPECIAL CERAMIC  
PRICE ON REQUEST (PAG 42)



BASE:		BRUSHED STAINLESS STEEL	ELECTRO POLISHED STAINLESS STEEL	POWDERCOATED STAINLESS STEEL WHITE	POWDERCOATED STAINLESS STEEL CENDRE	POWDERCOATED STAINLESS STEEL BLACK
TOP:						
GLASS 10 mm						
	WHITE	€ 5.100 DBL300GWU	€ 5.900 DBL300GEPWU	€ 5.900 DBL300GWRWU	€ 5.900 DBL300GCWU	€ 5.900 DBL300GAWU
	CENDRE	€ 5.100 DBL300GCLU	€ 5.900 DBL300GEPCLU	€ 5.900 DBL300GWRCLU	€ 5.900 DBL300GCCLU	€ 5.900 DBL300GACLU
	BLACK	€ 5.100 DBL300GZU	€ 5.900 DBL300GEPZU	€ 5.900 DBL300GWRZU	€ 5.900 DBL300GCZU	€ 5.900 DBL300GAZU
CERAMIC 10 mm						
	WHITE	€ 6.300 DBL300CWU	€ 7.100 DBL300CEPWU	€ 7.100 DBL300CWRWU	€ 7.100 DBL300CCWU	€ 7.100 DBL300CAWU
	CENDRE	€ 6.300 DBL300CPG	€ 7.100 DBL300CEPPG	€ 7.100 DBL300CWRPG	€ 7.100 DBL300CCPG	€ 7.100 DBL300CAPG
	BLACK	€ 6.300 DBL300CZU	€ 7.100 DBL300CEPZU	€ 7.100 DBL300CWRZU	€ 7.100 DBL300CCZU	€ 7.100 DBL300CAZU
TEAK 40 mm						
	TEAK	€ 5.100 DBL300T	€ 5.900 DBL300TEP	€ 5.900 DBL300TWR	€ 5.900 DBL300TC	€ 5.900 DBL300TA

DOBLE 300 GLASS  
M 0,81 m³ I 140,8 kgs

DOBLE 300 CERAMIC  
M 0,81 m³ I 140,8 kgs

DOBLE 300 TEAK  
M 0,68 m³ I 122,2 kgs



# CUSHIONS CIMA COLLECTION

## PRODUCT

SILLÓN CUSHION  
SEAT + BACK CUSHION



BUTAQUE CUSHION  
SEAT + BACK CUSHION



POLTRONA CUSHION  
SEAT + BACK CUSHION



## PRICES & REFERENCES

VERSION:	COLOUR:	WHITE	CAPPUCHINO / CENDRE	GREY	BLACK	NATTE DARK TAUPE	NATTE CARBON BEIGE	SUNBRELLA COMPLETE COLLECTION
SLIM TEMPOTEST®	€ 80	PIL-SLN-SWU	PIL-SLN-SCAU	PIL-SLN-SROU	PIL-SLN-SZU	-	-	-
SLIM SUNBRELLA@CAT.A	€ 140	-	-	-	-	PIL-SLN-SNDT	PIL-SLN-SNCB	CAT.A-CAT.B*

CUSHION SILLÓN SLIM  
M<sup>3</sup> 0,01 m<sup>3</sup> K<sup>G</sup> 0,5 kgs

VERSION:	COLOUR:	WHITE	CAPPUCHINO / CENDRE	GREY	BLACK	NATTE DARK TAUPE	NATTE CARBON BEIGE	SUNBRELLA COMPLETE COLLECTION
SLIM TEMPOTEST®	€ 80	PIL-BTQ-SWU	PIL-BTQ-SCAU	PIL-BTQ-SROU	PIL-BTQ-SZU	-	-	-
SLIM SUNBRELLA@CAT.A	€ 140	-	-	-	-	PIL-BTQ-SNDT	PIL-BTQ-SNCB	CAT.A-CAT.B*
STANDARD TEMPOTEST®	€ 225	PIL-BTQ-WU	PIL-BTQ-CAU	PIL-BTQ-ROU	PIL-BTQ-ZU	-	-	-
STANDARD SUNBRELLA@CAT.A	€ 260	-	-	-	-	PIL-BTQ-NDT	PIL-BTQ-NCB	CAT.A-CAT.B*
SYNTHETIC LEATHER STAMSKIN® WITHOUT BUTTONS	€ 270	PIL-BTQ-VCWU	PIL-BTQ-VCCE	-	PIL-BTQ-VCZU	-	-	-
SYNTHETIC LEATHER STAMSKIN® WITH BUTTONS	€ 320	PIL-BTQ-CWU	PIL-BTQ-CCE	-	PIL-BTQ-CZU	-	-	-

CUSHION BUTAQUE SLIM  
M<sup>3</sup> 0,01 m<sup>3</sup> K<sup>G</sup> 0,5 kgs

CUSHION BUTAQUE  
M<sup>3</sup> 0,02 m<sup>3</sup> K<sup>G</sup> 1,8 kgs

VERSION:	COLOUR:	WHITE	CAPPUCHINO / CENDRE	GREY	BLACK	NATTE CARBON BEIGE	NATTE CARBON BEIGE	SUNBRELLA COMPLETE COLLECTION
SLIM TEMPOTEST®	€ 90	PIL-PTN-SWU	PIL-PTN-SCAU	PIL-PTN-SROU	PIL-PTN-SZU	-	-	-
SLIM SUNBRELLA@CAT.A	€ 160	-	-	-	-	PIL-PTN-SNDT	PIL-PTN-SNCB	CAT.A-CAT.B*

CUSHION POLTRONA SLIM  
M<sup>3</sup> 0,01 m<sup>3</sup> K<sup>G</sup> 0,5 kgs

\* + PRICE SUPPLEMENT



### SUNBRELLA CUSHION FABRICS

QUICK PICK:

CAT. A:

CAT. B (+ PRICE SUPPLEMENT):

NATTE DARK TAUPE - NATTE CARBON BEIGE

SOLIDS & STRIPES - SOLIDS PREMIUM - BENGALI - CHECKS - DUPIONE - HERITAGE - NATTE - SLING LOGAN/AUGUSTINE

CHARTRES - DEAUVE - HEXAGON - KANOKO - LOPI - MARBLE - MOSAIC - PALAZZO - ROBBEN - SAVANE - SLING SAILING - TUNDRA

LEAD TIME FOR ALL SUNBRELLA FABRICS: 2 - 4 WEEKS

### CUSHIONS: MATERIAL & COLOURS

TEMPOTEST®

100% SOLUTION DYED ACRYLIC FABRIC



WHITE (WU)

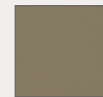

CAPPUCHINO (CAU)



GREY (ROU)



BLACK (ZU)

### CUSHIONS: MATERIAL & COLOURS

SUNBRELLA®

100% SOLUTION DYED ACRYLIC FABRIC

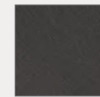

NATTE DARK TAUPE (NDT)



NATTE CARBON BEIGE (NCB)



CAT.A - CAT.B\*

PRODUCT

POLTRONA TRES CUSHION  
SEAT + BACK CUSHION

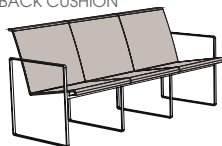

ESCABEL CUSHION  
SEAT CUSHION

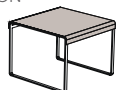

TUMBONA CUSHION  
SEAT + BACK CUSHION

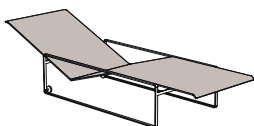

TABURETE CUSHION  
SEAT + BACK CUSHION



PRICES & REFERENCES

VERSION:	COLOUR:	WHITE	CAPPUCHINO / CENDRE	GREY	BLACK	NATTE DARK TAUPE	NATTE CARBON BEIGE	SUNBRELLA COMPLETE COLLECTION
SLIM TEMPOTEST®	€ 240	PIL-PTT-SWU	PIL-PTT-SCAU	PIL-PTT-SROU	PIL-PTT-SZU	-	-	-
SLIM SUNBRELLA@CAT.A	€ 480	-	-	-	-	PIL-PTT-SNDT	PIL-PTT-SNCB	CAT.A-CAT.B*

VERSION:	COLOUR:	WHITE	CAPPUCHINO / CENDRE	GREY	BLACK	NATTE DARK TAUPE	NATTE CARBON BEIGE	SUNBRELLA COMPLETE COLLECTION
SLIM TEMPOTEST®	€ 60	PIL-ESB-SWU	PIL-ESB-SCAU	PIL-ESB-SROU	PIL-ESB-SZU	-	-	-
SLIM SUNBRELLA@CAT.A	€ 100	-	-	-	-	PIL-ESB-SNDT	PIL-ESB-SNCB	CAT.A-CAT.B*

VERSION:	COLOUR:	WHITE	CAPPUCHINO / CENDRE	GREY	BLACK	NATTE DARK TAUPE	NATTE CARBON BEIGE	SUNBRELLA COMPLETE COLLECTION
SLIM TEMPOTEST®	€ 270	PIL-TBN-SWU	PIL-TBN-SCAU	PIL-TBN-SROU	PIL-TBN-SZU	-	-	-
SLIM SUNBRELLA@CAT.A	€ 480	-	-	-	-	PIL-TBN-SNDT	PIL-TBN-SNCB	CAT.A-CAT.B*

VERSION:	COLOUR:	WHITE	CAPPUCHINO / CENDRE	GREY	BLACK	NATTE DARK TAUPE	NATTE CARBON BEIGE	SUNBRELLA COMPLETE COLLECTION
SLIM TEMPOTEST®	€ 80	PIL-TBR-SWU	PIL-TBR-SCAU	PIL-TBR-SROU	PIL-TBR-SZU	-	-	-
SLIM SUNBRELLA@CAT.A	€ 150	-	-	-	-	PIL-TBR-SNDT	PIL-TBR-SNCB	CAT.A-CAT.B*

SPECS

CUSHION POLTRONA TRES SLIM  
M<sup>3</sup> 0,02 m<sup>3</sup> I 1,4 kgs

CUSHION ESCABEL SLIM  
M<sup>3</sup> 0,01 m<sup>3</sup> I 0,3 kgs

CUSHION TUMBONA SLIM  
M<sup>3</sup> 0,02 m<sup>3</sup> I 1,1 kgs

CUSHION TABURETE SLIM  
M<sup>3</sup> 0,01 m<sup>3</sup> I 0,3 kgs

\* + PRICE SUPPLEMENT

STAMSKIN®  
ALL WEATHER SYNTHETIC LEATHER WITHOUT BUTTONS

WHITE (VCWU)      CENDRE (VCCE)      BLACK (VCZU)

STAMSKIN®  
ALL WEATHER SYNTHETIC LEATHER WITH BUTTONS

WHITE (CWU)      CENDRE (CCE)      BLACK (CZU)

PRODUCT

DOBLE BENCH 160 CUSHION CUSHION

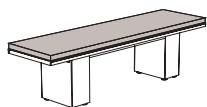

PRICES & REFERENCES

VERSION:	COLOUR:	WHITE	CAPPUCHINO / CENDRE	GREY	BLACK	NATTE DARK TAUPE	NATTE CARBON BEIGE	SUNBRELLA COMPLETE COLLECTION
SLIM TEMPOTEST®	€ 90	PIL-DBB160-SWU	PIL-DBB160-SCAU	PIL-DBB160-SROU	PIL-DBB160-SZU	-	-	-
SLIM SUNBRELLA®CAT.A	€ 160	-	-	-	-	PIL-DBB160-SNDT	PIL-DBB160-SNCB	CAT.A-CAT.B*
STANDARD TEMPOTEST®	€ 315	PIL-DBB160-WU	PIL-DBB160-CAU	PIL-DBB160-ROU	PIL-DBB160-ZU	-	-	-
STANDARD SUNBRELLA®CAT.A	€ 355	-	-	-	-	PIL-DBB160-NDT	PIL-DBB160-NCB	CAT.A-CAT.B*
SYNTHETIC LEATHER STAMSKIN® WITHOUT BUTTONS	€ 380	PIL-DBB160-VCWU	PIL-DBB160-VCCE	-	PIL-DBB160-VCZU	-	-	-
SYNTHETIC LEATHER STAMSKIN® WITH BUTTONS	€ 425	PIL-DBB160-CWU	PIL-DBB160-CCE	-	PIL-DBB160-CZU	-	-	-

SPECS

CUSHION DOBLEBENCH 160 SLIM  
 M<sup>3</sup> 0,02 m<sup>3</sup> K<sup>g</sup> 0,9 kgs

CUSHION DOBLEBENCH 160  
 M<sup>3</sup> 0,01 m<sup>3</sup> K<sup>g</sup> 0,5 kgs

DOBLE BENCH 240 CUSHION CUSHION

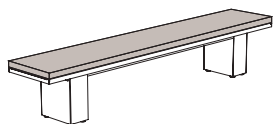

VERSION:	COLOUR:	WHITE	CAPPUCHINO / CENDRE	GREY	BLACK	NATTE DARK TAUPE	NATTE CARBON BEIGE	SUNBRELLA COMPLETE COLLECTION
SLIM TEMPOTEST®	€ 130	PIL-DBB240-SWU	PIL-DBB240-SCAU	PIL-DBB240-SROU	PIL-DBB240-SZU	-	-	-
SLIM SUNBRELLA®CAT.A	€ 240	-	-	-	-	PIL-DBB240-SNDT	PIL-DBB240-SNCB	CAT.A-CAT.B*
STANDARD TEMPOTEST®	€ 335	PIL-DBB240-WU	PIL-DBB240-CAU	PIL-DBB240-ROU	PIL-DBB240-ZU	-	-	-
STANDARD SUNBRELLA®CAT.A	€ 390	-	-	-	-	PIL-DBB240-NDT	PIL-DBB240-NCB	CAT.A-CAT.B*
SYNTHETIC LEATHER STAMSKIN® WITHOUT BUTTONS	€ 550	PIL-DBB240-VCWU	PIL-DBB240-VCCE	-	PIL-DBB240-VCZU	-	-	-
SYNTHETIC LEATHER STAMSKIN® WITH BUTTONS	€ 595	PIL-DBB240-CWU	PIL-DBB240-CCE	-	PIL-DBB240-CZU	-	-	-

CUSHION DOBLEBENCH 240 SLIM  
 M<sup>3</sup> 0,02 m<sup>3</sup> K<sup>g</sup> 1,3 kgs

CUSHION DOBLEBENCH 240  
 M<sup>3</sup> 0,11 m<sup>3</sup> K<sup>g</sup> 5,4 kgs

\* + PRICE SUPPLEMENT



SUNBRELLA CUSHION FABRICS

QUICK PICK:

CAT. A:

CAT. B (+ PRICE SUPPLEMENT):

NATTE DARK TAUPE - NATTE CARBON BEIGE

SOLIDS & STRIPES - SOLIDS PREMIUM - BENGALI - CHECKS - DUPIONE - HERITAGE - NATTE - SLING LOGAN/AUGUSTINE

CHARTRES - DEAUVE - HEXAGON - KANOKO - LOPI - MARBLE - MOSAIC - PALAZZO - ROBBEN - SAVANE - SLING SAILING - TUNDRA

LEAD TIME FOR ALL SUNBRELLA FABRICS: 2 - 4 WEEKS

CUSHIONS: MATERIAL & COLOURS

TEMPOTEST®

100% SOLUTION DYED ACRYLIC FABRIC



WHITE (WU)

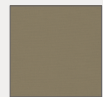

CAPPUCHINO (CAU)



GREY (ROU)



BLACK (ZU)

CUSHIONS: MATERIAL & COLOURS

SUNBRELLA®

100% SOLUTION DYED ACRYLIC FABRIC



NATTE DARK TAUPE (NDT)



NATTE CARBON BEIGE (NCB)



CAT.A - CAT.B\*

# LOUNGE COLLECTION

## PRODUCT

### POLTRONA LOUNGE EASY CHAIR

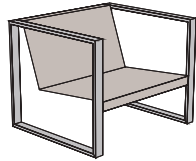

ARMREST:	BRUSHED STAINLESS STEEL	ELECTRO POLISHED STAINLESS STEEL	POWDERCOATED STAINLESS STEEL WHITE	POWDERCOATED STAINLESS STEEL CENDRE	POWDERCOATED STAINLESS STEEL BLACK	TEAK
SEAT:						
BATYLINE®						
WHITE	€ 2.300 PTLWU	€ 2.700 PTLEPWU	€ 2.700 PTLWRWU	-	-	€ 2.700 PTLTWU
CENDRE	€ 2.300 PTLCE	€ 2.700 PTLEPCE	-	€ 2.700 PTLCCE	-	€ 2.700 PTLTCE
BLACK	€ 2.300 PTLZU	€ 2.700 PTLEPZU	-	-	€ 2.700 PTLAZU	€ 2.700 PTLTZU
CUSHION SET	STANDARD TEMPOTEST®   SUNBRELLA®@CAT.A € 380   € 420		COZY TEMPOTEST®   SUNBRELLA®@CAT.A € 420   € 450		SYNTHETIC LEATHER STAMSKIN® WITHOUT BUTTONS € 490	
					SYNTHETIC LEATHER STAMSKIN® WITH BUTTONS € 520	

FOR MORE INFORMATION ABOUT CUSHIONS SEE PAGE 30

## SPECS

### POLTRONA LOUNGE

M 0,57 m³ 28,5 kgs

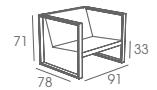

### POLTRONA LOUNGE TEAK

M 0,49 m³ 25,1 kgs

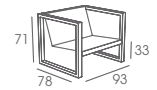

### BANCA LOUNGE SOFA

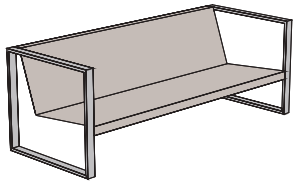

ARMREST:	BRUSHED STAINLESS STEEL	ELECTRO POLISHED STAINLESS STEEL	POWDERCOATED STAINLESS STEEL WHITE	POWDERCOATED STAINLESS STEEL CENDRE	POWDERCOATED STAINLESS STEEL BLACK	TEAK
SEAT:						
BATYLINE®						
WHITE	€ 3.190 BCLWU	€ 3.590 BCLEPWU	€ 3.590 BCLWRWU	-	-	€ 3.590 BCLTWU
CENDRE	€ 3.190 BCLCE	€ 3.590 BCLEPCE	-	€ 3.590 BCLCCE	-	€ 3.590 BCLTCE
BLACK	€ 3.190 BCLZU	€ 3.590 BCLEPZU	-	-	€ 3.590 BCLAZU	€ 3.590 BCLTZU
CUSHION SET	STANDARD TEMPOTEST®   SUNBRELLA®@CAT.A € 830   € 960		COZY TEMPOTEST®   SUNBRELLA®@CAT.A € 960   € 990		SYNTHETIC LEATHER STAMSKIN® WITHOUT BUTTONS € 1.100	
					SYNTHETIC LEATHER STAMSKIN® WITH BUTTONS € 1.200	

FOR MORE INFORMATION ABOUT CUSHIONS SEE PAGE 31

### BANCA LOUNGE

M 1,24 m³ 39,2 kgs

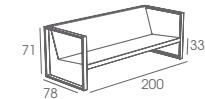

### BANCA LOUNGE TEAK

M 0,69 m³ 35,8 kgs

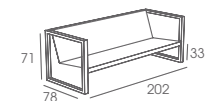

### PIECERA 78 LOUNGE FOOTREST

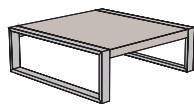

FRAME:	BRUSHED STAINLESS STEEL	ELECTRO POLISHED STAINLESS STEEL	POWDERCOATED STAINLESS STEEL WHITE	POWDERCOATED STAINLESS STEEL CENDRE	POWDERCOATED STAINLESS STEEL BLACK	TEAK
SEAT:						
BATYLINE®						
WHITE	€ 1.410 PCL78WU	€ 1.580 PCL78EPWU	€ 1.580 PCL78WRWU	-	-	-
CENDRE	€ 1.410 PCL78CE	€ 1.580 PCL78EPCE	-	€ 1.580 PCL78CCE	-	-
BLACK	€ 1.410 PCL78ZU	€ 1.580 PCL78EPZU	-	-	€ 1.580 PCL78AZU	-
CUSHION	STANDARD TEMPOTEST®   SUNBRELLA®@CAT.A € 280   € 370		COZY TEMPOTEST®   SUNBRELLA®@CAT.A € 370   € 410		SYNTHETIC LEATHER STAMSKIN® WITHOUT BUTTONS € 440	
					SYNTHETIC LEATHER STAMSKIN® WITH BUTTONS € 480	

FOR MORE INFORMATION ABOUT CUSHIONS SEE PAGE 32

### PIECERA 78 LOUNGE

M 0,28 m³ 23,2 kgs

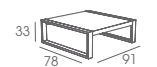

PRODUCT

PIECERA 130 LOUNGE  
FOOTREST

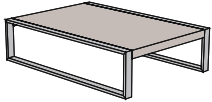

PRICES & REFERENCES

FRAME:	BRUSHED STAINLESS STEEL	ELECTRO POLISHED STAINLESS STEEL	POWDERCOATED STAINLESS STEEL WHITE	POWDERCOATED STAINLESS STEEL CENDRE	POWDERCOATED STAINLESS STEEL BLACK	TEAK
SEAT:						
BATYLINE®						
WHITE	€ 1.710 PCL130WU	€ 1.840 PCL130EPWU	€ 1.840 PCL130WRWU	-	-	-
CENDRE	€ 1.710 PCL130CE	€ 1.840 PCL130EPCE	-	€ 1.840 PCL130CCE	-	-
BLACK	€ 1.710 PCL130ZU	€ 1.840 PCL130EPZU	-	-	€ 1.840 PCL130AZU	-
CUSHION	STANDARD TEMPOTEST®   SUNBRELLA@CAT.A € 470   € 560		COZY TEMPOTEST®   SUNBRELLA@CAT.A € 560   € 630		SYNTHETIC LEATHER STAMSKIN® WITHOUT BUTTONS € 640	
					SYNTHETIC LEATHER STAMSKIN® WITH BUTTONS € 670	

FOR MORE INFORMATION ABOUT CUSHIONS SEE PAGE 32

SPECS

PIECERA 130 LOUNGE

M 0,55 m³ | P 33,0 kgs

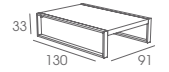

SIESTA LOUNGE  
SUNLOUNGER

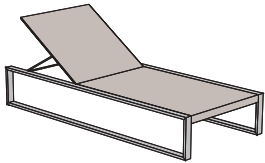

FRAME:	BRUSHED STAINLESS STEEL	ELECTRO POLISHED STAINLESS STEEL	POWDERCOATED STAINLESS STEEL WHITE	POWDERCOATED STAINLESS STEEL CENDRE	POWDERCOATED STAINLESS STEEL BLACK	TEAK
SEAT:						
BATYLINE®						
WHITE	€ 2.800 STLWU	€ 3.200 STLEPWU	€ 3.200 STLWRWU	-	-	-
CENDRE	€ 2.800 STLCE	€ 3.200 STLEPCE	-	€ 3.200 STLCCE	-	-
BLACK	€ 2.800 STLZU	€ 3.200 STLEPZU	-	-	€ 3.200 STLAZU	-
CUSHION	STANDARD TEMPOTEST®   SUNBRELLA@CAT.A € 890   € 950		SYNTHETIC LEATHER STAMSKIN® WITHOUT BUTTONS € 990		SYNTHETIC LEATHER STAMSKIN® WITH BUTTONS € 1.100	

FOR MORE INFORMATION ABOUT CUSHIONS SEE PAGE 33

SIESTA LOUNGE

M 0,77 m³ | P 56,0 kgs

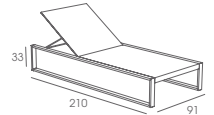

SIESTA LOUNGE TWIN  
SUNLOUNGER

- LEAD TIME 24 WEEKS

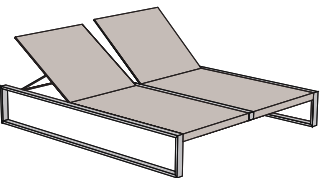

FRAME:	BRUSHED STAINLESS STEEL	ELECTRO POLISHED STAINLESS STEEL	POWDERCOATED STAINLESS STEEL WHITE	POWDERCOATED STAINLESS STEEL CENDRE	POWDERCOATED STAINLESS STEEL BLACK	TEAK
SEAT:						
BATYLINE®						
WHITE	€ 6.200 STL2WU	€ 6.800 STL2EPWU	€ 6.800 STL2WRWU	-	-	-
CENDRE	€ 6.200 STL2CE	€ 6.400 STL2EPCE	-	€ 6.800 STL2CCE	-	-
BLACK	€ 6.200 STL2ZU	€ 6.800 STL2EPZU	-	-	€ 6.800 STL2AZU	-
CUSHION	STANDARD TEMPOTEST®   SUNBRELLA@CAT.A € 1.780   € 1.900		SYNTHETIC LEATHER STAMSKIN® WITHOUT BUTTONS € 1.980		SYNTHETIC LEATHER STAMSKIN® WITH BUTTONS € 2.200	
					2x SIESTA LOUNGE CUSHION	

FOR MORE INFORMATION ABOUT CUSHIONS SEE PAGE 33

SIESTA LOUNGE TWIN

M 1,55 m³ | P 92,9 kgs

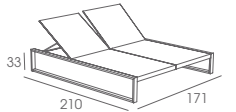

PRODUCT

TABLA 150 LOUNGE  
LOW TABLE

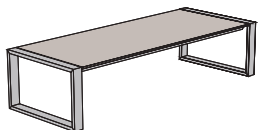

SPECIAL CERAMIC  
PRICE ON REQUEST (PAG 42)



PRICES & REFERENCES

TOP:	BASE:	BRUSHED STAINLESS STEEL	ELECTRO POLISHED STAINLESS STEEL	POWDERCOATED STAINLESS STEEL WHITE	POWDERCOATED STAINLESS STEEL CENDRE	POWDERCOATED STAINLESS STEEL BLACK	TEAK
GLASS 10 mm	WHITE	€ 1.225 TLL150GWU	€ 1.470 TLL150GEPWU	€ 1.470 TLL150GWRWU	€ 1.470 TLL150GCWU	€ 1.470 TLL150GAWU	€ 1.470 TLL150GTWU
	CENDRE	€ 1.225 TLL150GCLU	€ 1.470 TLL150GEPCLU	€ 1.470 TLL150GWRCLU	€ 1.470 TLL150GCCLU	€ 1.470 TLL150GACLU	€ 1.470 TLL150GTCLU
	BLACK	€ 1.225 TLL150GZU	€ 1.470 TLL150GEPZU	€ 1.470 TLL150GWRZU	€ 1.470 TLL150GCZU	€ 1.470 TLL150GAZU	€ 1.470 TLL150GTZU
CERAMIC 10 mm	WHITE	€ 1.620 TLL150CWU	€ 1.820 TLL150CEPWU	€ 1.820 TLL150CWRWU	€ 1.820 TLL150CCWU	€ 1.820 TLL150CAWU	€ 1.820 TLL150CTWU
	CENDRE	€ 1.620 TLL150CPG	€ 1.820 TLL150CEPPG	€ 1.820 TLL150CWRPG	€ 1.820 TLL150CCPG	€ 1.820 TLL150CAPG	€ 1.820 TLL150CTPG
	BLACK	€ 1.620 TLL150CZU	€ 1.820 TLL150CEPZU	€ 1.820 TLL150CWRZU	€ 1.820 TLL150CCZU	€ 1.820 TLL150CAZU	€ 1.820 TLL150CTZU
TEAK 20 mm	TEAK	€ 1.225 TLL150T	€ 1.470 TLL150TEP	€ 1.470 TLL150TWR	€ 1.470 TLL150TC	€ 1.470 TLL150TA	€ 1.470 TLL150TT

SPECS

TABLA 150 LOUNGE

GLASS	M <sup>3</sup>	0,41 m <sup>3</sup>	35,2 kgs
CERAMIC	M <sup>3</sup>	0,41 m <sup>3</sup>	35,2 kgs
TEAK	M <sup>3</sup>	0,41 m <sup>3</sup>	32,8 kgs



TABLA 150 LOUNGE TEAK

GLASS	M <sup>3</sup>	0,11 m <sup>3</sup>	33,8 kgs
CERAMIC	M <sup>3</sup>	0,11 m <sup>3</sup>	33,8 kgs
TEAK	M <sup>3</sup>	0,11 m <sup>3</sup>	31,0 kgs



TABLA 200 LOUNGE  
LOW TABLE

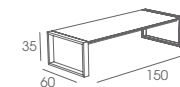

SPECIAL CERAMIC  
PRICE ON REQUEST (PAG 42)

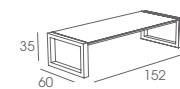
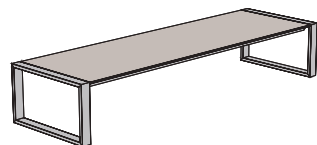

TOP:	BASE:	BRUSHED STAINLESS STEEL	ELECTRO POLISHED STAINLESS STEEL	POWDERCOATED STAINLESS STEEL WHITE	POWDERCOATED STAINLESS STEEL CENDRE	POWDERCOATED STAINLESS STEEL BLACK	TEAK
GLASS 10 mm	WHITE	€ 1.740 TLL200GWU	€ 1.850 TLL200GEPWU	€ 1.850 TLL200GWRWU	€ 1.850 TLL200GCWU	€ 1.850 TLL200GAWU	€ 1.850 TLL200GTWU
	CENDRE	€ 1.740 TLL200GCLU	€ 1.850 TLL200GEPCLU	€ 1.850 TLL200GWRCLU	€ 1.850 TLL200GCCLU	€ 1.850 TLL200GACLU	€ 1.850 TLL200GTCLU
	BLACK	€ 1.740 TLL200GZU	€ 1.850 TLL200GEPZU	€ 1.850 TLL200GWRZU	€ 1.850 TLL200GCZU	€ 1.850 TLL200GAZU	€ 1.850 TLL200GTZU
CERAMIC 10 mm	WHITE	€ 1.990 TLL200CWU	€ 2.100 TLL200CEPWU	€ 2.100 TLL200CWRWU	€ 2.100 TLL200CCWU	€ 2.100 TLL200CAWU	€ 2.100 TLL200CTWU
	CENDRE	€ 1.990 TLL200CPG	€ 2.100 TLL200CEPPG	€ 2.100 TLL200CWRPG	€ 2.100 TLL200CCPG	€ 2.100 TLL200CAPG	€ 2.100 TLL200CTPG
	BLACK	€ 1.990 TLL200CZU	€ 2.100 TLL200CEPZU	€ 2.100 TLL200CWRZU	€ 2.100 TLL200CCZU	€ 2.100 TLL200CAZU	€ 2.100 TLL200CTZU
TEAK 20 mm	TEAK	€ 1.740 TLL200T	€ 1.850 TLL200TEP	€ 1.850 TLL200TWR	€ 1.850 TLL200TC	€ 1.850 TLL200TA	€ 1.850 TLL200TT

TABLA 200 LOUNGE

GLASS	M <sup>3</sup>	0,57 m <sup>3</sup>	38,2 kgs
CERAMIC	M <sup>3</sup>	0,57 m <sup>3</sup>	38,2 kgs
TEAK	M <sup>3</sup>	0,57 m <sup>3</sup>	35,8 kgs



TABLA 200 LOUNGE TEAK

GLASS	M <sup>3</sup>	0,13 m <sup>3</sup>	36,8 kgs
CERAMIC	M <sup>3</sup>	0,13 m <sup>3</sup>	36,8 kgs
TEAK	M <sup>3</sup>	0,13 m <sup>3</sup>	34,4 kgs

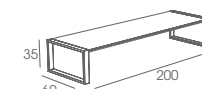
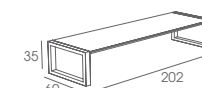

PRODUCT

MESITA 45 LOUNGE  
SIDE TABLE

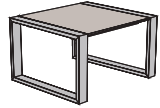

SPECIAL CERAMIC  
PRICE ON REQUEST (PAG 42)



PRICES & REFERENCES

TOP:	BASE:	BRUSHED STAINLESS STEEL	ELECTRO POLISHED STAINLESS STEEL	POWDERCOATED STAINLESS STEEL WHITE	POWDERCOATED STAINLESS STEEL CENDRE	POWDERCOATED STAINLESS STEEL BLACK	TEAK
GLASS 10 mm	WHITE	€ 790 MSL45GWU	€ 890 MSL45GEPWU	€ 890 MSL45GWRWU	€ 890 MSL45GCWU	€ 890 MSL45GAWU	€ 890 MSL45GTWU
	CENDRE	€ 790 MSL45GCLU	€ 890 MSL45GEPCLU	€ 890 MSL45GWRCLU	€ 890 MSL45GCCLU	€ 890 MSL45GACLU	€ 890 MSL45GTCLU
	BLACK	€ 790 MSL45GZU	€ 890 MSL45GEPZU	€ 890 MSL45GWRZU	€ 890 MSL45GCZU	€ 890 MSL45GAZU	€ 890 MSL45GTZU
CERAMIC 10 mm	WHITE	€ 880 MSL45CWU	€ 980 MSL45CEPWU	€ 980 MSL45CWRWU	€ 980 MSL45CCWU	€ 980 MSL45CAWU	€ 980 MSL45CTWU
	CENDRE	€ 880 MSL45CPG	€ 980 MSL45CEPPG	€ 980 MSL45CWRPG	€ 980 MSL45CCPG	€ 980 MSL45CAPG	€ 980 MSL45CTPG
	BLACK	€ 880 MSL45CZU	€ 980 MSL45CEPZU	€ 980 MSL45CWRZU	€ 980 MSL45CCZU	€ 980 MSL45CAZU	€ 980 MSL45CTZU
TEAK 20 mm	TEAK	€ 790 MSL45T	€ 890 MSL45TEP	€ 890 MSL45TWR	€ 890 MSL45TC	€ 890 MSL45TA	€ 890 MSL45TT

SPECS

MESITA 45 LOUNGE  
GLASS 0,12 m³ 14,6 kgs  
CERAMIC 0,12 m³ 14,6 kgs  
TEAK 0,12 m³ 13,5 kgs

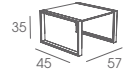

MESITA 45 LOUNGE TEAK  
GLASS 0,03 m³ 13,6 kgs  
CERAMIC 0,03 m³ 13,6 kgs  
TEAK 0,03 m³ 12,5 kgs

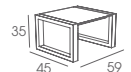

MESITA 78 LOUNGE  
LOW TABLE

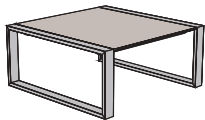

SPECIAL CERAMIC  
PRICE ON REQUEST (PAG 42)



TOP:	BASE:	BRUSHED STAINLESS STEEL	ELECTRO POLISHED STAINLESS STEEL	POWDERCOATED STAINLESS STEEL WHITE	POWDERCOATED STAINLESS STEEL CENDRE	POWDERCOATED STAINLESS STEEL BLACK	TEAK
GLASS 10 mm	WHITE	€ 1.070 MSL78GWU	€ 1.220 MSL78GEPWU	€ 1.220 MSL78GWRWU	€ 1.220 MSL78GCWU	€ 1.220 MSL78GAWU	€ 1.220 MSL78GTWU
	CENDRE	€ 1.070 MSL78GCLU	€ 1.220 MSL78GEPCLU	€ 1.220 MSL78GWRCLU	€ 1.220 MSL78GCCLU	€ 1.220 MSL78GACLU	€ 1.220 MSL78GTCLU
	BLACK	€ 1.070 MSL78GZU	€ 1.220 MSL78GEPZU	€ 1.220 MSL78GWRZU	€ 1.220 MSL78GCZU	€ 1.220 MSL78GAZU	€ 1.220 MSL78GTZU
CERAMIC 10 mm	WHITE	€ 1.225 MSL78CWU	€ 1.440 MSL78CEPWU	€ 1.440 MSL78CWRWU	€ 1.440 MSL78CCWU	€ 1.440 MSL78CAWU	€ 1.440 MSL78CTWU
	CENDRE	€ 1.225 MSL78CPG	€ 1.440 MSL78CEPPG	€ 1.440 MSL78CWRPG	€ 1.440 MSL78CCPG	€ 1.440 MSL78CAPG	€ 1.440 MSL78CTPG
	BLACK	€ 1.225 MSL78CZU	€ 1.440 MSL78CEPZU	€ 1.440 MSL78CWRZU	€ 1.440 MSL78CCZU	€ 1.440 MSL78CAZU	€ 1.440 MSL78CTZU
TEAK 20 mm	TEAK	€ 1070 MSL78T	€ 1.220 MSL78TEP	€ 1.220 MSL78TWR	€ 1.220 MSL78TC	€ 1.220 MSL78TA	€ 1.220 MSL78TT

MESITA 78 LOUNGE  
GLASS 0,23 m³ 27,2 kgs  
CERAMIC 0,23 m³ 27,2 kgs  
TEAK 0,23 m³ 25,4 kgs

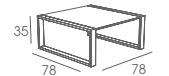

MESITA 78 LOUNGE TEAK  
GLASS 0,14 m³ 25,0 kgs  
CERAMIC 0,14 m³ 25,0 kgs  
TEAK 0,14 m³ 23,8 kgs

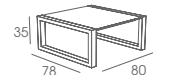

PRODUCT

MESITA 91 LOUNGE  
LOW TABLE

PRICES & REFERENCES

SPECS

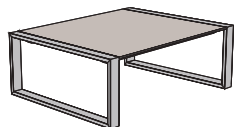

SPECIAL CERAMIC  
PRICE ON REQUEST (PAG 42)



TOP:	BASE:	BRUSHED STAINLESS STEEL	ELECTRO POLISHED STAINLESS STEEL	POWDERCOATED STAINLESS STEEL WHITE	POWDERCOATED STAINLESS STEEL CENDRE	POWDERCOATED STAINLESS STEEL BLACK	TEAK
GLASS 10 mm	WHITE	€ 1.095 MSL91GWU	€ 1.320 MSL91GEPWU	€ 1.320 MSL91GWRWU	€ 1.320 MSL91GCWU	€ 1.320 MSL91GAWU	€ 1.320 MSL91GTWU
	CENDRE	€ 1.095 MSL91GCLU	€ 1.320 MSL91GEPCLU	€ 1.320 MSL91GWRCLU	€ 1.320 MSL91GCCLU	€ 1.320 MSL91GACLU	€ 1.320 MSL91GTCLU
	BLACK	€ 1.095 MSL91GZU	€ 1.320 MSL91GEPZU	€ 1.320 MSL91GWRZU	€ 1.320 MSL91GCZU	€ 1.320 MSL91GAZU	€ 1.320 MSL91GTZU
CERAMIC 10 mm	WHITE	€ 1.400 MSL91CWU	€ 1.540 MSL91CEPWU	€ 1.540 MSL91CWRWU	€ 1.540 MSL91CCWU	€ 1.540 MSL91CAWU	€ 1.540 MSL91CTWU
	CENDRE	€ 1.400 MSL91CPG	€ 1.540 MSL91CEPPG	€ 1.540 MSL91CWRPG	€ 1.540 MSL91CCPG	€ 1.540 MSL91CAPG	€ 1.540 MSL91CTPG
	BLACK	€ 1.400 MSL91CZU	€ 1.540 MSL91CEPZU	€ 1.540 MSL91CWRZU	€ 1.540 MSL91CCZU	€ 1.540 MSL91CAZU	€ 1.540 MSL91CTZU
TEAK 20 mm	TEAK	€ 1.095 MSL91T	€ 1.320 MSL91TEP	€ 1.320 MSL91TWR	€ 1.320 MSL91TC	€ 1.320 MSL91TA	€ 1.320 MSL91TT

MESITA 91 LOUNGE  
GLASS 0,29 m³ 29,4 kgs  
CERAMIC 0,29 m³ 29,4 kgs  
TEAK 0,29 m³ 27,1 kgs

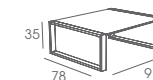

MESITA 91 LOUNGE TEAK  
GLASS 0,16 m³ 27,4 kgs  
CERAMIC 0,16 m³ 27,4 kgs  
TEAK 0,16 m³ 24,9 kgs

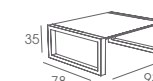

POLTRONA LOUNGE TEAK BLACK WITH STAMSKIN® CUSHIONS WITH BUTTONS & MESITA 91 LOUNGE TEAK



# LOUNGE COLLECTION - MODULAR LOUNGE SETS

EXAMPLES OF ARRANGEMENTS OF MODULAR LOUNGE SETS

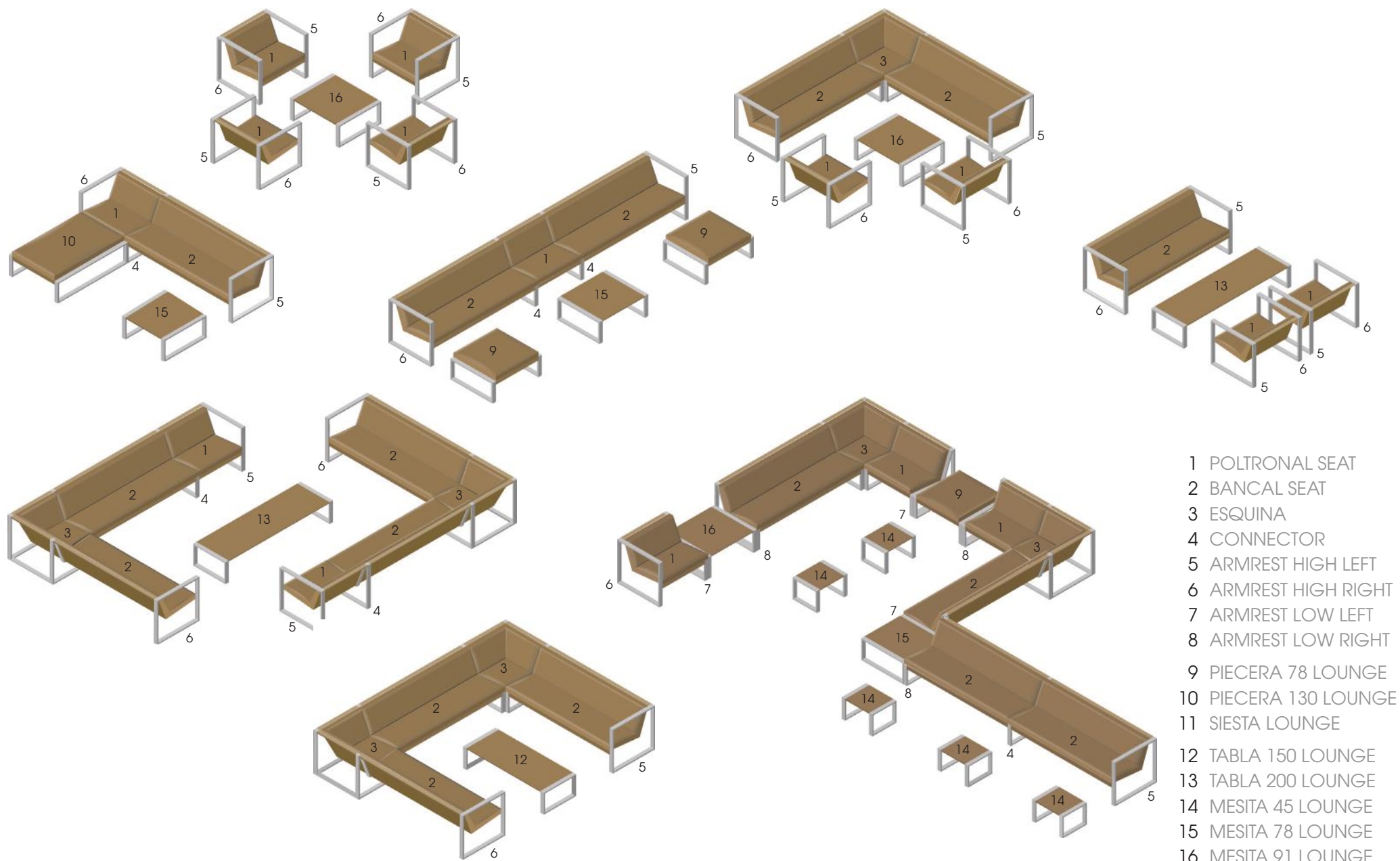

- 1 POLTRONAL SEAT
- 2 BANCAL SEAT
- 3 ESQUINA
- 4 CONNECTOR
- 5 ARMREST HIGH LEFT
- 6 ARMREST HIGH RIGHT
- 7 ARMREST LOW LEFT
- 8 ARMREST LOW RIGHT
- 9 PIECERA 78 LOUNGE
- 10 PIECERA 130 LOUNGE
- 11 SIESTA LOUNGE
- 12 TABLA 150 LOUNGE
- 13 TABLA 200 LOUNGE
- 14 MESITA 45 LOUNGE
- 15 MESITA 78 LOUNGE
- 16 MESITA 91 LOUNGE

# MODULAR LOUNGE SYSTEM PARTS

## PRODUCT

**ESQUINA LOUNGE**  
MODULAR CORNER SEAT  
(NO CONNECTOR NEEDED)

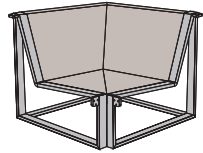

## PRICES & REFERENCES

SEAT:	FRAME:	BRUSHED STAINLESS STEEL	ELECTRO POLISHED STAINLESS STEEL	POWDERCOATED STAINLESS STEEL WHITE	POWDERCOATED STAINLESS STEEL CENDRE	POWDERCOATED STAINLESS STEEL BLACK	TEAK
	BATYLINE®						
WHITE		€ 1.960 ESQWU	€ 2.270 ESQEPWU	€ 2.270 ESQWRWU	-	-	-
CENDRE		€ 1.960 ESQCE	€ 2.270 ESQEPCE	-	€ 2.270 ESQCCE	-	-
BLACK		€ 1.960 ESQZU	€ 2.270 ESQEPZU	-	-	€ 2.270 ESQAZU	-
CUSHION SET		STANDARD TEMPOTEST®   SUNBRELLA®@CAT.A € 630   € 680	COZY TEMPOTEST®   SUNBRELLA®@CAT.A € 680   € 750	SYNTHETIC LEATHER STAMSKIN® WITHOUT BUTTONS € 770	SYNTHETIC LEATHER STAMSKIN® WITH BUTTONS € 810		

FOR MORE INFORMATION ABOUT CUSHIONS SEE PAGE 30

## SPECS

ESQUINA LOUNGE  
M 0,57 m³ | 28,5 kgs

**POLTRONA LOUNGE SEAT**  
MODULAR SINGLE SEAT

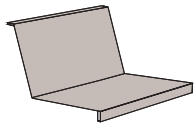

SEAT:	FRAME:	STAINLESS STEEL EP
BATYLINE®		
WHITE		€ 1.100 PTLSEATEPWU
CENDRE		€ 1.100 PTLSEATEPCE
BLACK		€ 1.100 PTLSEATEPZU
CUSHION SET		FOR MORE INFORMATION ABOUT CUSHIONS FOR THE MODULAR SYSTEM SEE PAGE 30

**BANCA LOUNGE SEAT**  
MODULAR DOUBLE SEAT

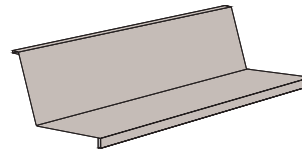

SEAT:	FRAME:	STAINLESS STEEL EP
BATYLINE®		
WHITE		€ 1.990 BCLSEATEPWU
CENDRE		€ 1.990 BCLSEATEPCE
BLACK		€ 1.990 BCLSEATEPZU
CUSHION SET		FOR MORE INFORMATION ABOUT CUSHIONS FOR THE MODULAR SYSTEM SEE PAGE 31

POLTRONA LOUNGE SEAT  
M 0,31 m³ | 11,7 kgs

BANCA LOUNGE SEAT  
M 0,51 m³ | 22,4 kgs

## HOW TO USE AN ESQUINA LOUNGE & MODULAR SEATS:

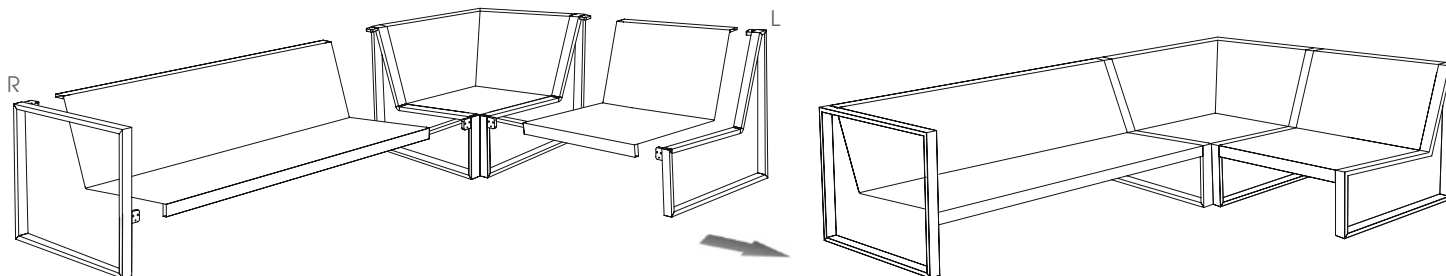

# MODULAR LOUNGE SYSTEM PARTS

## PRODUCT PRICES & REFERENCES SPECS

**ARMRESTS**  
MODULAR ARMREST  
LEFT OR RIGHT (WHEN SEATED)

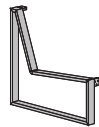
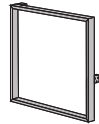

FRAME:	BRUSHED STAINLESS STEEL	ELECTRO POLISHED STAINLESS STEEL	POWDERCOATED STAINLESS STEEL WHITE	POWDERCOATED STAINLESS STEEL CENDRE	POWDERCOATED STAINLESS STEEL BLACK	TEAK
<b>ARMREST HIGH</b>						
LEFT:	€ 600 CNHL	€ 800 CNHLEP	€ 800 CNHLWR	€ 800 CNHLC	€ 800 CNHLA	€ 800 CNHLT
RIGHT:	€ 600 CNHR	€ 800 CNHREP	€ 800 CNHRWR	€ 800 CNHRC	€ 800 CNHRA	€ 800 CNHRT
<b>ARMREST LOW</b>						
LEFT:	€ 600 CNL	€ 800 CNLEP	€ 800 CNLWR	€ 800 CNLC	€ 800 CNLA	-
RIGHT:	€ 600 CNR	€ 800 CNREP	€ 800 CNRWR	€ 800 CNRC	€ 800 CNRA	-

**ARMREST HIGH**  
SS M 0,08 m³ 8,9 kgs  
TEAK M 0,09 m³ 6,7 kgs

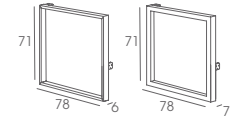

**ARMREST LOW**

M 0,08 m³ 8,8 kgs

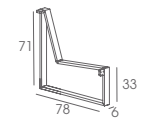

**CONNECTOR**  
MODULAR SEAT CONNECTOR

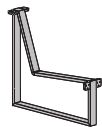

FRAME:	BRUSHED STAINLESS STEEL	ELECTRO POLISHED STAINLESS STEEL	POWDERCOATED STAINLESS STEEL WHITE	POWDERCOATED STAINLESS STEEL CENDRE	POWDERCOATED STAINLESS STEEL BLACK	TEAK
<b>CONNECTOR</b>	€ 600 CNC	€ 700 CNCEP	€ 700 CNCWR	€ 700 CNCC	€ 700 CNCA	-

**CONNECTOR**  
M 0,09 m³ 8,9 kgs

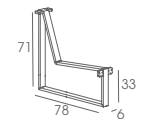

### HOW TO USE AN LOUNGE CONNECTOR:

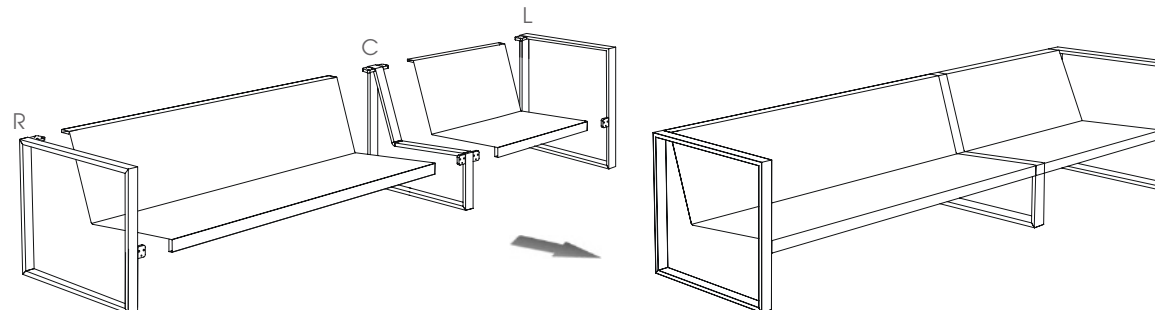

STANDARD ARRANGEMENTS OF MODULAR LOUNGE SETS

ARRANGEMENT 1  
MODULAR LOUNGE SET

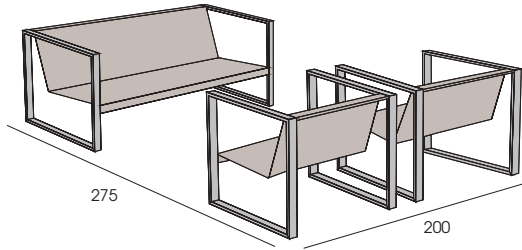

BRUSHED FRAME PC / EP / TEAK FRAME  
 SET PRICE  
 € 7.790 € 8.990

ARRANGEMENT 4  
MODULAR LOUNGE SET

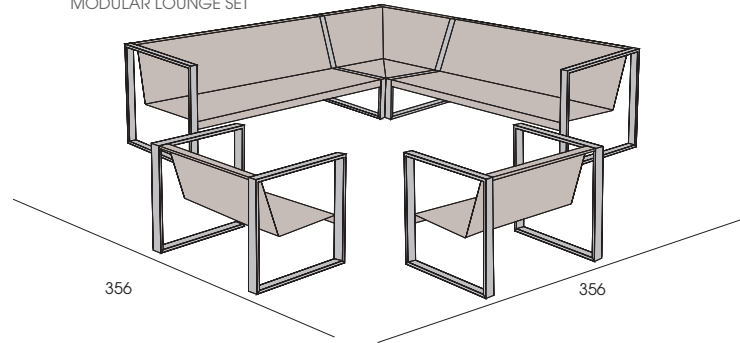

BRUSHED FRAME PC / EP / TEAK FRAME  
 SET PRICE  
 € 11.740 € 13.250

ARRANGEMENT 2  
MODULAR LOUNGE SET

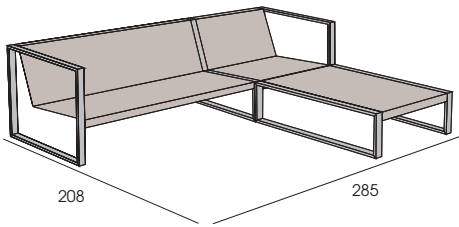

BRUSHED FRAME PC / EP / TEAK FRAME  
 SET PRICE  
 € 6.600 € 7.230

ARRANGEMENT 5  
MODULAR LOUNGE SET

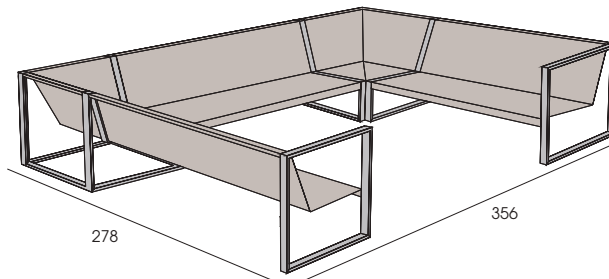

BRUSHED FRAME PC / EP / TEAK FRAME  
 SET PRICE  
 € 11.090 € 12.110

ARRANGEMENT 3  
MODULAR LOUNGE SET

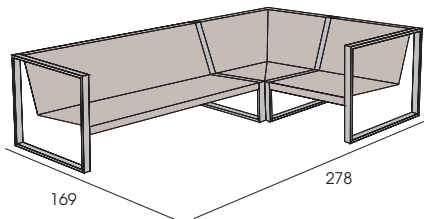

BRUSHED FRAME PC / EP / TEAK FRAME  
 SET PRICE  
 € 6.250 € 6.960

ARRANGEMENT 6  
MODULAR LOUNGE SET

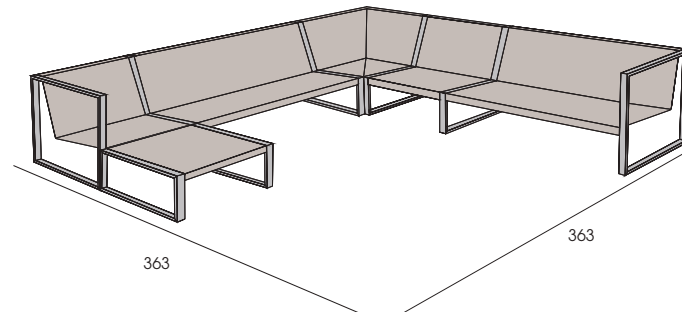





BRUSHED FRAME PC / EP / TEAK FRAME  
 SET PRICE  
 € 11.950 € 13.030

# CUSHIONS LOUNGE COLLECTION

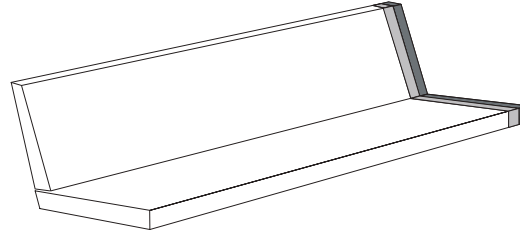
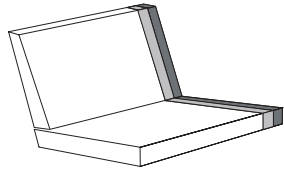
## WHEN TO USE THE EXTRA LARGE CUSHIONS FOR THE POLTRONA & BANCA LOUNGE

DIFFERENT SIZED CUSHIONS ARE AVAILABLE FOR THE POLTRONA LOUNGE AND BANCA LOUNGE. THE REGULAR SIZE IS TO BE USED IN THE REGULAR SETTING WITH ARMREST. THE XL AND XXL CUSHIONS EXTEND OVER THE CONNECTOR OR THE FRAME OF THE ESQUINA LOUNGE (SEE PICTURE BELOW). THE XL CUSHIONS ARE TO BE USED IN CASE OF A MODULAR COMBINATION OF ONE POLTRONA LOUNGE OR BANCA LOUNGE WITH A CONNECTOR OR ESQUINA LOUNGE. THE XXL POLTRONA LOUNGE AND BANCA LOUNGE CUSHION IS TO BE USED IF THE BANCA LOUNGE SEAT IS EXTENDED ON BOTH SIDES BY A CONNECTOR OR ESQUINA LOUNGE.



-  CUSHION POLTRONA LOUNGE - REGULAR SIZE (79 cm)
-  CUSHION POLTRONA LOUNGE - XL (+6 cm)
-  CUSHION POLTRONA LOUNGE - XXL (+12 cm)

-  CUSHION BANCA LOUNGE - REGULAR SIZE (188 cm)
-  CUSHION BANCA LOUNGE - XL (+6 cm)
-  CUSHION BANCA LOUNGE - XXL (+12 cm)



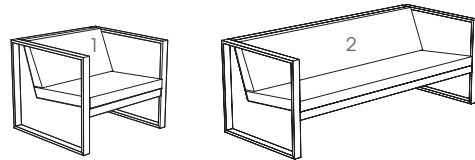

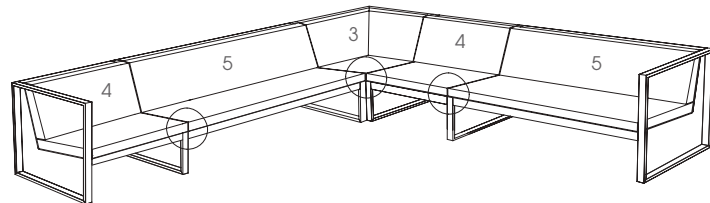
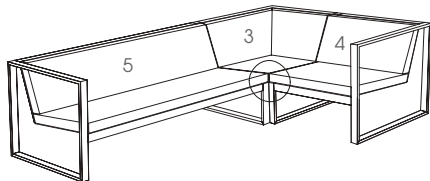
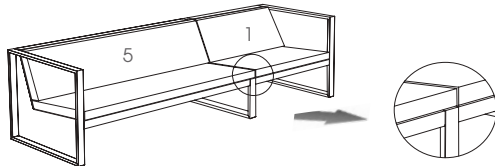

### REGULAR SIZE CUSHION



### XL CUSHION



### PRODUCTS: REFERENCE:

- |   |  |                             |             |
|---|--|-----------------------------|-------------|
| 1 |    | POLTRONA LOUNGE CUSHION     | PIL-PTL-    |
| 2 |    | BANCA LOUNGE CUSHION        | PIL-BCL-    |
| 3 |    | ESQUINA LOUNGE CUSHION      | PIL-ESQ-    |
| 4 |    | XL POLTRONA LOUNGE CUSHION  | PIL-XLPTL-  |
| 5 |   | XL BANCA LOUNGE CUSHION     | PIL-XLBCL-  |
| 6 |  | XXL POLTRONA LOUNGE CUSHION | PIL-XXLPTL- |
| 7 |  | XXL BANCA LOUNGE CUSHION    | PIL-XXLBCL- |

### XXL CUSHION

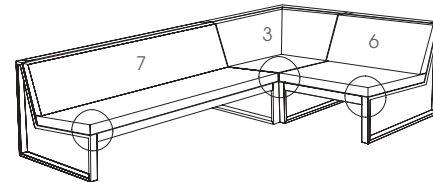

## CUSHION VERSIONS

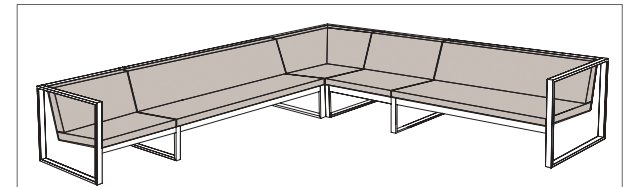

- STANDARD** SUNBRELLA® / TEMPOTEST® 100% SOLUTION DYED ACRYLIC FABRIC
-  NATTE DARK TAUPE (NDT)
  -  NATTE CARBON BEIGE (NCB)
  -  SUNBRELLA COMPLETE COLLECTION CAT.A - CAT.B\*

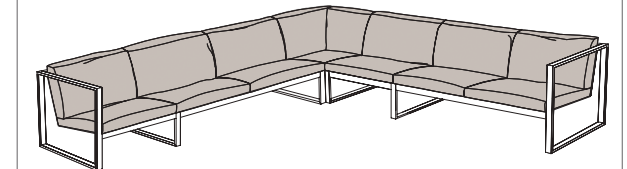

- COZY** SUNBRELLA® / TEMPOTEST® 100% SOLUTION DYED ACRYLIC FABRIC
-  WHITE (YWU)
  -  GREY (YROU)
  -  CAPPUCHINO (YCAU)
  -  BLACK (YZU)

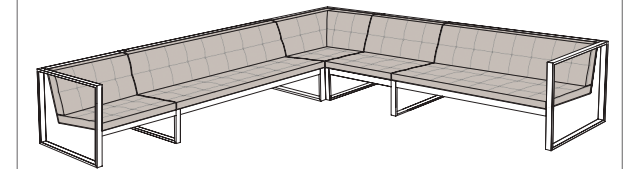

- SYNTHETIC LEATHER WITH BUTTONS** STAMSKIN® ALL WEATHER SYNTHETIC LEATHER
- STAMSKIN®** ZEN TOP NEO
-  WHITE (CWU)
  -  CENDRE (CCE)
  -  BLACK (CZU)

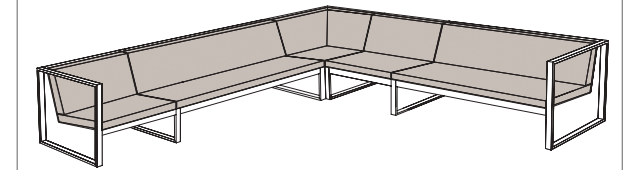

- SYNTHETIC LEATHER WITHOUT BUTTONS** STAMSKIN® ALL WEATHER SYNTHETIC LEATHER
- STAMSKIN®** ZEN TOP NEO
-  WHITE (VCWU)
  -  CENDRE (VCCE)
  -  BLACK (VCZU)

PRODUCT

PRICES & REFERENCES

SPECS

ESQUINA LOUNGE CUSHION SET

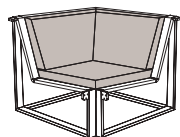

VERSION:	COLOUR:	WHITE	CAPPUCHINO / CENDRE	GREY	BLACK	NATTE DARK TAUPE	NATTE CARBON BEIGE	SUNBRELLA COMPLETE COLLECTION
STANDARD TEMPOTEST®	€ 630	PIL-ESQ-WU	PIL-ESQ-CAU	PIL-ESQ-ROU	PIL-ESQ-ZU	-	-	-
STANDARD SUNBRELLA®@CATA	€ 680	-	-	-	-	PIL-ESQ-NDT	PIL-ESQ-NCB	CAT.A-CAT.B*
COZY TEMPOTEST®	€ 680	PIL-ESQ-YWU	PIL-ESQ-YCAU	PIL-ESQ-YROU	PIL-ESQ-YZU	-	-	-
COZY SUNBRELLA®@CATA	€ 750	-	-	-	-	PIL-ESQ-YNDT	PIL-ESQ-YNCB	CAT.A-CAT.B*
SYNTHETIC LEATHER STAMSKIN® WITHOUT BUTTONS	€ 770	PIL-ESQ-VCWU	PIL-ESQ-VCCE	-	PIL-ESQ-VCZU	-	-	-
SYNTHETIC LEATHER STAMSKIN® WITH BUTTONS	€ 810	PIL-ESQ-CWU	PIL-ESQ-CCE	-	PIL-ESQ-CZU	-	-	-

CUSHION ESQUINA LOUNGE  
 0,10 m³ 5,8 kgs

POLTRONA LOUNGE CUSHION SET

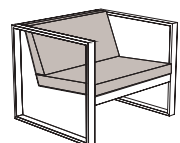

VERSION:	COLOUR:	WHITE	CAPPUCHINO / CENDRE	GREY	BLACK	NATTE DARK TAUPE	NATTE CARBON BEIGE	SUNBRELLA COMPLETE COLLECTION
STANDARD TEMPOTEST®	€ 380	PIL-PTL-WU	PIL-PTL-CAU	PIL-PTL-ROU	PIL-PTL-ZU	-	-	-
STANDARD SUNBRELLA®@CATA	€ 420	-	-	-	-	PIL-PTL-NDT	PIL-PTL-NCB	CAT.A-CAT.B*
COZY TEMPOTEST®	€ 420	PIL-PTL-YWU	PIL-PTL-YCAU	PIL-PTL-YROU	PIL-PTL-YZU	-	-	-
COZY SUNBRELLA®@CATA	€ 450	-	-	-	-	PIL-PTL-YNDT	PIL-PTL-YNCB	CAT.A-CAT.B*
SYNTHETIC LEATHER STAMSKIN® WITHOUT BUTTONS	€ 490	PIL-PTL-VCWU	PIL-PTL-VCCE	-	PIL-PTL-VCZU	-	-	-
SYNTHETIC LEATHER STAMSKIN® WITH BUTTONS	€ 520	PIL-PTL-CWU	PIL-PTL-CCE	-	PIL-PTL-CZU	-	-	-

CUSHION POLTRONA LOUNGE  
 0,09 m³ 3,8 kgs

XL POLTRONA LOUNGE CUSHION SET

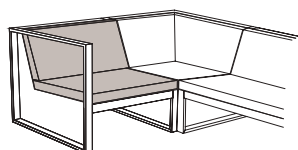

VERSION:	COLOUR:	WHITE	CAPPUCHINO / CENDRE	GREY	BLACK	NATTE DARK TAUPE	NATTE CARBON BEIGE	SUNBRELLA COMPLETE COLLECTION
STANDARD TEMPOTEST®	€ 400	PIL-XLPTL-WU	PIL-XLPTL-CAU	PIL-XLPTL-ROU	PIL-XLPTL-ZU	-	-	-
STANDARD SUNBRELLA®@CATA	€ 440	-	-	-	-	PIL-XLPTL-NDT	PIL-XLPTL-NCB	CAT.A-CAT.B*
COZY TEMPOTEST®	€ 440	PIL-XLPTL-YWU	PIL-XLPTL-YCAU	PIL-XLPTL-YROU	PIL-XLPTL-YZU	-	-	-
COZY SUNBRELLA®@CATA	€ 480	-	-	-	-	PIL-XLPTL-YNDT	PIL-XLPTL-YNCB	CAT.A-CAT.B*
SYNTHETIC LEATHER STAMSKIN® WITHOUT BUTTONS	€ 500	PIL-XLPTL-VCWU	PIL-XLPTL-VCCE	-	PIL-XLPTL-VCZU	-	-	-
SYNTHETIC LEATHER STAMSKIN® WITH BUTTONS	€ 540	PIL-XLPTL-CWU	PIL-XLPTL-CCE	-	PIL-XLPTL-CZU	-	-	-

XL CUSHION POLTRONA LOUNGE  
 0,10 m³ 4,0 kgs

\* + PRICE SUPPLEMENT

STAMSKIN®  
ALL WEATHER SYNTHETIC LEATHER WITHOUT BUTTONS

STAMSKIN®  
ZEN TOP NEO

WHITE (VCWU)

CENDRE (VCCE)

BLACK (VCZU)

STAMSKIN®  
ALL WEATHER SYNTHETIC LEATHER WITH BUTTONS

STAMSKIN®  
ZEN TOP NEO

WHITE (CWU)

CENDRE (CCE)

BLACK (CZU)

PRODUCT

PRICES & REFERENCES

SPECS

XXL POLTRONA LOUNGE CUSHION SET

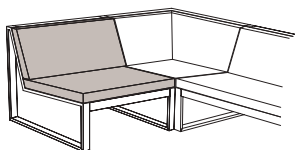

VERSION:	COLOUR:	WHITE	CAPPUCHINO / CENDRE	GREY	BLACK	NATTE DARK TAUPE	NATTE CARBON BEIGE	SUNBRELLA COMPLETE COLLECTION
STANDARD TEMPOTEST®	€ 420	PIL-XXLPTL-WU	PIL-XXLPTL-CAU	PIL-XXLPTL-ROU	PIL-XXLPTL-ZU	-	-	-
STANDARD SUNBRELLA®/CAT.A	€ 470	-	-	-	-	PIL-XXLPTL-NDT	PIL-XXLPTL-NCB	CAT.A-CAT.B*
COZY TEMPOTEST®	€ 470	PIL-XXLPTL-YWU	PIL-XXLPTL-YCAU	PIL-XXLPTL-YROU	PIL-XXLPTL-YZU	-	-	-
COZY SUNBRELLA®/CAT.A	€ 495	-	-	-	-	PIL-XXLPTL-YNDT	PIL-XXLPTL-YNCB	CAT.A-CAT.B*
SYNTHETIC LEATHER STAMSKIN® WITHOUT BUTTONS	€ 530	PIL-XXLPTL-VCWU	PIL-XXLPTL-VCCE	-	PIL-XXLPTL-VCZU	-	-	-
SYNTHETIC LEATHER STAMSKIN® WITH BUTTONS	€ 600	PIL-XXLPTL-CWU	PIL-XXLPTL-CCE	-	PIL-XXLPTL-CZU	-	-	-

XXL CUSHION POLTRONA LOUNGE

M<sup>3</sup> 0,11 m<sup>3</sup> K<sup>g</sup> 4,2 kgs

BANCA LOUNGE CUSHION SET

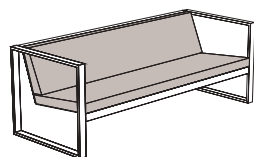

VERSION:	COLOUR:	WHITE	CAPPUCHINO / CENDRE	GREY	BLACK	NATTE DARK TAUPE	NATTE CARBON BEIGE	SUNBRELLA COMPLETE COLLECTION
STANDARD TEMPOTEST®	€ 830	PIL-BCL-WU	PIL-BCL-CAU	PIL-BCL-ROU	PIL-BCL-ZU	-	-	-
STANDARD SUNBRELLA®/CAT.A	€ 960	-	-	-	-	PIL-BCL-NDT	PIL-BCL-NCB	CAT.A-CAT.B*
COZY TEMPOTEST®	€ 960	PIL-BCL-YWU	PIL-BCL-YCAU	PIL-BCL-YROU	PIL-BCL-YZU	-	-	-
COZY SUNBRELLA®/CAT.A	€ 990	-	-	-	-	PIL-BCL-YNDT	PIL-BCL-YNCB	CAT.A-CAT.B*
SYNTHETIC LEATHER STAMSKIN® WITHOUT BUTTONS	€ 1.100	PIL-BCL-VCWU	PIL-BCL-VCCE	-	PIL-BCL-VCZU	-	-	-
SYNTHETIC LEATHER STAMSKIN® WITH BUTTONS	€ 1.200	PIL-BCL-CWU	PIL-BCL-CCE	-	PIL-BCL-CZU	-	-	-

CUSHION BANCA LOUNGE

M<sup>3</sup> 0,21 m<sup>3</sup> K<sup>g</sup> 7,8 kgs

XL BANCA LOUNGE CUSHION SET

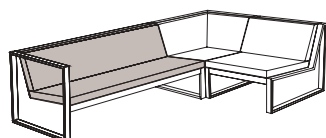

VERSION:	COLOUR:	WHITE	CAPPUCHINO / CENDRE	GREY	BLACK	NATTE DARK TAUPE	NATTE CARBON BEIGE	SUNBRELLA COMPLETE COLLECTION
STANDARD TEMPOTEST®	€ 850	PIL-XLBCL-WU	PIL-XLBCL-CAU	PIL-XLBCL-ROU	PIL-XLBCL-ZU	-	-	-
STANDARD SUNBRELLA®/CAT.A	€ 990	-	-	-	-	PIL-XLBCL-NDT	PIL-XLBCL-NCB	CAT.A-CAT.B*
COZY TEMPOTEST®	€ 990	PIL-XLBCL-YWU	PIL-XLBCL-YCAU	PIL-XLBCL-YROU	PIL-XLBCL-YZU	-	-	-
COZY SUNBRELLA®/CAT.A	€ 1.000	-	-	-	-	PIL-XLBCL-YNDT	PIL-XLBCL-YNCB	CAT.A-CAT.B*
SYNTHETIC LEATHER STAMSKIN® WITHOUT BUTTONS	€ 1.200	PIL-XLBCL-VCWU	PIL-XLBCL-VCCE	-	PIL-XLBCL-VCZU	-	-	-
SYNTHETIC LEATHER STAMSKIN® WITH BUTTONS	€ 1.350	PIL-XLBCL-CWU	PIL-XLBCL-CCE	-	PIL-XLBCL-CZU	-	-	-

XL CUSHION BANCA LOUNGE

M<sup>3</sup> 0,22 m<sup>3</sup> K<sup>g</sup> 8,0 kgs

\* + PRICE SUPPLEMENT

CUSHIONS: MATERIAL & COLOURS

TEMPOTEST®

100% SOLUTION DYED ACRYLIC FABRIC



WHITE (WU)

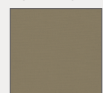

CAPPUCHINO (CAU)



GREY (ROU)



BLACK (ZU)

CUSHIONS: MATERIAL & COLOURS

SUNBRELLA®

100% SOLUTION DYED ACRYLIC FABRIC

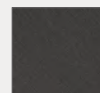

NATTE DARK TAUPE (NDT)



NATTE CARBON BEIGE (NCB)



CAT.A - CAT.B\*

PRODUCT

PRICES & REFERENCES

SPECS

XXL BANCA LOUNGE CUSHION SET

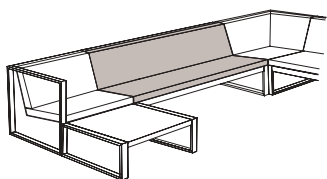

VERSION:	COLOUR:	WHITE	CAPPUCHINO / CENDRE	GREY	BLACK	NATTE DARK TAUPE	NATTE CARBON BEIGE	SUNBRELLA COMPLETE COLLECTION
STANDARD TEMPOTEST®	€ 880	PIL-XXLBCL-WU	PIL-XXLBCL-CAU	PIL-XXLBCL-ROU	PIL-XXLBCL-ZU	-	-	-
STANDARD SUNBRELLA®/CATA	€ 1.000	-	-	-	-	PIL-XXLBCL-NDT	PIL-XXLBCL-NCB	CAT.A-CAT.B*
COZY TEMPOTEST®	€ 1.000	PIL-XXLBCL-YWU	PIL-XXLBCL-YCAU	PIL-XXLBCL-YROU	PIL-XXLBCL-YZU	-	-	-
COZY SUNBRELLA®/CATA	€ 1.100	-	-	-	-	PIL-XXLBCL-YNDT	PIL-XXLBCL-YNCB	CAT.A-CAT.B*
SYNTHETIC LEATHER STAMSKIN® WITHOUT BUTTONS	€ 1.350	PIL-XXLBCL-VCWU	PIL-XXLBCL-VCCE	-	PIL-XXLBCL-VCZU	-	-	-
SYNTHETIC LEATHER STAMSKIN® WITH BUTTONS	€ 1.500	PIL-XXLBCL-CWU	PIL-XXLBCL-CCE	-	PIL-XXLBCL-CZU	-	-	-

XXL CUSHION BANCA LOUNGE

M<sup>3</sup> 0,23 m<sup>3</sup> K<sup>g</sup> 8,2 kgs

PIECERA 78 LOUNGE CUSHION

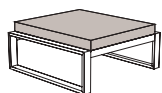

VERSION:	COLOUR:	WHITE	CAPPUCHINO / CENDRE	GREY	BLACK	NATTE DARK TAUPE	NATTE CARBON BEIGE	SUNBRELLA COMPLETE COLLECTION
STANDARD TEMPOTEST®	€ 280	PIL-PCL78-WU	PIL-PCL78-CAU	PIL-PCL78-ROU	PIL-PCL78-ZU	-	-	-
STANDARD SUNBRELLA®/CATA	€ 370	-	-	-	-	PIL-PCL78-NDT	PIL-PCL78-NCB	CAT.A-CAT.B*
COZY TEMPOTEST®	€ 370	PIL-PCL78-YWU	PIL-PCL78-YCAU	PIL-PCL78-YROU	PIL-PCL78-YZU	-	-	-
COZY SUNBRELLA®/CATA	€ 410	-	-	-	-	PIL-PCL78-YNDT	PIL-PCL78-YNCB	CAT.A-CAT.B*
SYNTHETIC LEATHER STAMSKIN® WITHOUT BUTTONS	€ 440	PIL-PCL78-VCWU	PIL-PCL78-VCCE	-	PIL-PCL78-VCZU	-	-	-
SYNTHETIC LEATHER STAMSKIN® WITH BUTTONS	€ 480	PIL-PCL78-CWU	PIL-PCL78-CCE	-	PIL-PCL78-CZU	-	-	-

CUSHION PIECERA 78 LOUNGE

M<sup>3</sup> 0,06 m<sup>3</sup> K<sup>g</sup> 3,2 kgs

PIECERA 130 LOUNGE CUSHION

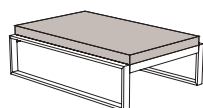

VERSION:	COLOUR:	WHITE	CAPPUCHINO / CENDRE	GREY	BLACK	NATTE DARK TAUPE	NATTE CARBON BEIGE	SUNBRELLA COMPLETE COLLECTION
STANDARD TEMPOTEST®	€ 470	PIL-PCL130-WU	PIL-PCL130-CAU	PIL-PCL130-ROU	PIL-PCL130-ZU	-	-	-
STANDARD SUNBRELLA®/CATA	€ 560	-	-	-	-	PIL-PCL130-NDT	PIL-PCL130-NCB	CAT.A-CAT.B*
COZY TEMPOTEST®	€ 560	PIL-PCL130-YWU	PIL-PCL130-YCAU	PIL-PCL130-YROU	PIL-PCL130-YZU	-	-	-
COZY SUNBRELLA®/CATA	€ 630	-	-	-	-	PIL-PCL130-YNDT	PIL-PCL130-YNCB	CAT.A-CAT.B*
SYNTHETIC LEATHER STAMSKIN® WITHOUT BUTTONS	€ 640	PIL-PCL130-VCWU	PIL-PCL130-VCCE	-	PIL-PCL130-VCZU	-	-	-
SYNTHETIC LEATHER STAMSKIN® WITH BUTTONS	€ 670	PIL-PCL130-CWU	PIL-PCL130-CCE	-	PIL-PCL130-CZU	-	-	-

CUSHION PIECERA 130 LOUNGE

M<sup>3</sup> 0,10 m<sup>3</sup> K<sup>g</sup> 5,0 kgs

\* + PRICE SUPPLEMENT

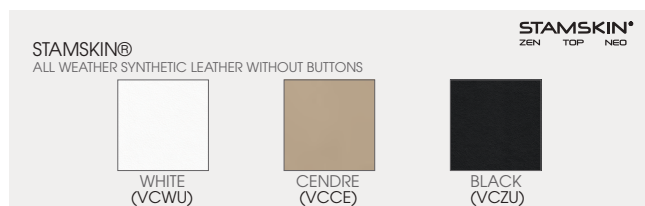



PRODUCT

PRICES & REFERENCES

SPECS

SIESTA LOUNGE CUSHION

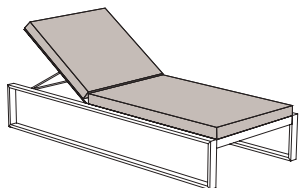

VERSION:	COLOUR:	WHITE	CAPPUCHINO / CENDRE	GREY	BLACK	NATTE DARK TAUPE	NATTE CARBON BEIGE	SUNBRELLA COMPLETE COLLECTION
STANDARD TEMPOTEST®	€ 810	PIL-STL-WU	PIL-STL-CAU	PIL-STL-ROU	PIL-STL-ZU	-	-	-
STANDARD SUNBRELLA®/CATA	€ 890	-	-	-	-	PIL-STL-NDT	PIL-STL-NCB	CAT.A-CAT.B*
COZY TEMPOTEST®	€ 890	PIL-STL-YWU	PIL-STL-YCAU	PIL-STL-YROU	PIL-STL-YZU	-	-	-
COZY SUNBRELLA®/CATA	€ 950	-	-	-	-	PIL-STL-YNDT	PIL-STL-YNCB	CAT.A-CAT.B*
SYNTHETIC LEATHER STAMSKIN® WITHOUT BUTTONS	€ 990	PIL-STL-VCWU	PIL-STL-VCCE	-	PIL-STL-VCZU	-	-	-
SYNTHETIC LEATHER STAMSKIN® WITH BUTTONS	€ 1.100	PIL-STL-CWU	PIL-STL-CCE	-	PIL-STL-CZU	-	-	-

\* SIESTA LOUNGE TWIN REQUIRES TWO CUSHIONS

CUSHION SIESTA LOUNGE

M 0,20 m³ I 9,4 kgs

SIESTA LOUNGE HEAD CUSHION

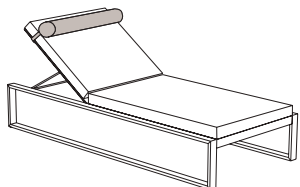

VERSION:	COLOUR:	WHITE	CAPPUCHINO / CENDRE	GREY	BLACK	NATTE DARK TAUPE	NATTE CARBON BEIGE	SUNBRELLA COMPLETE COLLECTION
STANDARD TEMPOTEST®	€ 150	PIL-RLL-WU	PIL-RLL-CAU	PIL-RLL-ROU	PIL-RLL-ZU	-	-	-
STANDARD SUNBRELLA®/CATA	€ 195	-	-	-	-	PIL-RLL-NDT	PIL-RLL-NCB	CAT.A-CAT.B*
SYNTHETIC LEATHER STAMSKIN® WITH BUTTONS	€ 200	PIL-RLL-VYWU	PIL-RLL-VCCE	-	PIL-RLL-VCZU	-	-	-

HEAD CUSHION SIESTA LOUNGE

M 0,01 m³ I 2,9 kgs

LOUNGE ARMREST COVERS

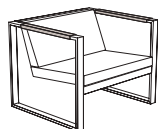

	COLOUR:	WHITE BATYLINE®	CENDRE BATYLINE®	BLACK BATYLINE®
ARMREST SET BATYLINE® MESH FABRIC	€ 30	BAT-LARM-WU	BAT-LARM-CE	BAT-LARM-ZU

LOUNGE ARMREST COVERS

M 0,01 m³ I 0,2 kgs

\* + PRICE SUPPLEMENT



SUNBRELLA CUSHION FABRICS

QUICK PICK:

CAT. A:  
CAT. B (+ PRICE SUPPLEMENT):

NATTE DARK TAUPE - NATTE CARBON BEIGE  
SOLIDS & STRIPES - SOLIDS PREMIUM - BENGALI - CHECKS - DUPIONE - HERITAGE - NATTE - SLING LOGAN/AUGUSTINE  
CHARTRES - DEAUVE - HEXAGON - KANOKO - LOPI - MARBLE - MOSAIC - PALAZZO - ROBBEN - SAVANE - SLING SAILING - TUNDRA

LEAD TIME FOR ALL SUNBRELLA FABRICS: 2 - 4 WEEKS

CUSHIONS: MATERIAL & COLOURS  
TEMPOTEST®  
100% SOLUTION DYED ACRYLIC FABRIC

WHITE (WU)	CAPPUCHINO (CAU)	GREY (ROU)	BLACK (ZU)

CUSHIONS: MATERIAL & COLOURS  
SUNBRELLA®  
100% SOLUTION DYED ACRYLIC FABRIC

NATTE DARK TAUPE (NDT)	NATTE CARBON BEIGE (NCB)	CAT.A - CAT.B*

# SHELL COLLECTION

## PRODUCT

### SHELL CHAIR CHAIR



FRAME:	BRUSHED STAINLESS STEEL	ELECTRO POLISHED STAINLESS STEEL	POWDERCOATED STAINLESS STEEL WHITE	POWDERCOATED STAINLESS STEEL CENDRE	POWDERCOATED STAINLESS STEEL BLACK	TEAK
SEAT:						
BATYLINE © FIBRE WHITE	LEADTIME 24 WEEKS	€ 880 SCREPWU	-	-	-	€ 880 SCRTWU
CENDRE		€ 880 SCREPC	-	-	-	€ 880 SCRTCE
BLACK		€ 880 SCREPZU	-	-	-	€ 880 SCRTZU
CUSHION	STANDARD TEMPOTEST®   SUNBRELLA®/CAT.A € 95   € 130 FOR MORE INFORMATION ABOUT CUSHIONS SEE PAGE 38					

### SHELL CHAIR

M 0,19 m³ 12,5 kgs

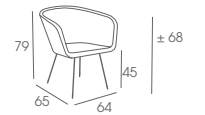

### SHELL CHAIR TEAK

M 0,19 m³ 12,5 kgs

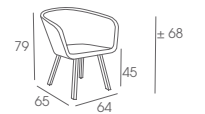

### SHELL EASY CHAIR EASY CHAIR

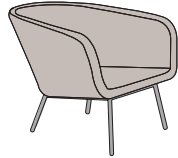

FRAME:	BRUSHED STAINLESS STEEL	ELECTRO POLISHED STAINLESS STEEL	POWDERCOATED STAINLESS STEEL WHITE	POWDERCOATED STAINLESS STEEL CENDRE	POWDERCOATED STAINLESS STEEL BLACK	TEAK
SEAT:						
BATYLINE © FIBRE WHITE	LEADTIME 24 WEEKS	€ 1.290 SECEPWU	-	-	-	€ 1.290 SECTWU
CENDRE	-	€ 1.290 SECEPC	-	-	-	€ 1.290 SECTCE
BLACK	-	€ 1.290 SECEPZU	-	-	-	€ 1.290 SECTZU
CUSHION	STANDARD TEMPOTEST®   SUNBRELLA®/CAT.A € 110   € 150 FOR MORE INFORMATION ABOUT CUSHIONS SEE PAGE 38					

### SHELL EASY CHAIR

M 0,27 m³ 14,6 kgs

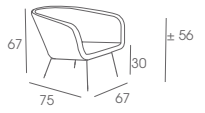

### SHELL EASY CHAIR TEAK

M 0,27 m³ 14,6 kgs

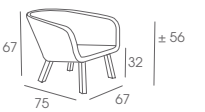

### SHELL ROCKING CHAIR EASY ROCKING CHAIR

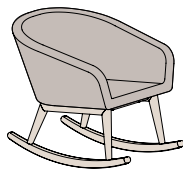

FRAME:	BRUSHED STAINLESS STEEL	ELECTRO POLISHED STAINLESS STEEL	POWDERCOATED STAINLESS STEEL WHITE	POWDERCOATED STAINLESS STEEL CENDRE	POWDERCOATED STAINLESS STEEL BLACK	TEAK
SEAT:						
BATYLINE © FIBRE WHITE	LEADTIME 24 WEEKS	-	-	-	-	€ 1.650 SRCWU
CENDRE	-	-	-	-	-	€ 1.650 SRCCE
BLACK	-	-	-	-	-	€ 1.650 SRCZU
CUSHION	STANDARD TEMPOTEST®   SUNBRELLA®/CAT.A € 110   € 150 FOR MORE INFORMATION ABOUT CUSHIONS SEE PAGE 38					

### SHELL ROCKING CHAIR

M 0,27 m³ 14,6 kgs

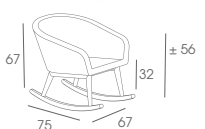

PRODUCT

SHELL SOFA  
SOFA

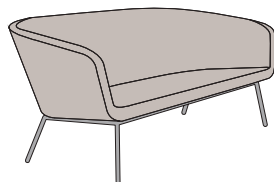

PRICES & REFERENCES

FRAME:	BRUSHED STAINLESS STEEL	ELECTRO POLISHED STAINLESS STEEL	POWDERCOATED STAINLESS STEEL WHITE	POWDERCOATED STAINLESS STEEL CENDRE	POWDERCOATED STAINLESS STEEL BLACK	TEAK
SEAT:						
BATYLINE® FIBRE WHITE	LEADTIME 24 WEEKS	€ 1.920 SSFEPWU	-	-	-	€ 1.920 SSFTWU
CENDRE	-	€ 1.920 SSFEPCE	-	-	-	€ 1.920 SSFTCE
BLACK	-	€ 1.920 SSFEPZU	-	-	-	€ 1.920 SSFTZU
CUSHION	STANDARD TEMPOTEST®   SUNBRELLA®/CAT.A € 210   € 250 FOR MORE INFORMATION ABOUT CUSHIONS SEE PAGE 38					

SPECS

SHELL SOFA

M 0,57 m³ | 29,0 kgs

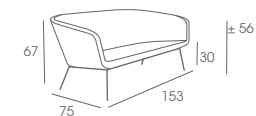

SHELL SOFA TEAK

M 0,57 m³ | 29,0 kgs

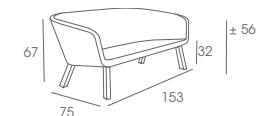

SHELL SUNBED  
SUNBED

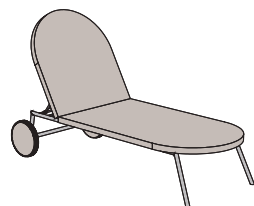

FRAME:	BRUSHED STAINLESS STEEL	ELECTRO POLISHED STAINLESS STEEL	POWDERCOATED STAINLESS STEEL WHITE	POWDERCOATED STAINLESS STEEL CENDRE	POWDERCOATED STAINLESS STEEL BLACK	TEAK
SEAT:						
BATYLINE® FIBRE WHITE	LEADTIME 24 WEEKS	€ 2.100 SSBEPWU	-	-	-	€ 2.100 SSBTWU
CENDRE	-	€ 2.100 SSBEPCE	-	-	-	€ 2.100 SSBTCE
BLACK	-	€ 2.100 SSBEPZU	-	-	-	€ 2.100 SSBTZU
CUSHION	STANDARD TEMPOTEST®   SUNBRELLA®/CAT.A € 430   € 460 FOR MORE INFORMATION ABOUT CUSHIONS SEE PAGE 38					

SHELL SUNBED

M 0,61 m³ | 31,3 kgs



SHELL SUNBED TEAK

M 0,61 m³ | 31,3 kgs



PRODUCT

SHELL DINING 100  
TABLE



PRICES & REFERENCES

TOP: GLASS 10 mm	BASE:	BRUSHED STAINLESS STEEL	ELECTRO POLISHED STAINLESS STEEL	POWDERCOATED STAINLESS STEEL WHITE	POWDERCOATED STAINLESS STEEL CENDRE	POWDERCOATED STAINLESS STEEL BLACK
		WHITE	-	€ 1.380 SDN100GEPWU	-	-
CENDRE	-	€ 1.380 SDN100GEPCLU	-	-	-	
BLACK	-	€ 1.380 SDN100GEPZU	-	-	-	

SPECS

SHELL DINING 100  
 M 0,37 m³ 39,6 kgs

SHELL DINING 120  
TABLE



TOP: GLASS 10 mm	BASE:	BRUSHED STAINLESS STEEL	ELECTRO POLISHED STAINLESS STEEL	POWDERCOATED STAINLESS STEEL WHITE	POWDERCOATED STAINLESS STEEL CENDRE	POWDERCOATED STAINLESS STEEL BLACK
		WHITE	-	€ 1.520 SDN120GEPWU	-	-
CENDRE	-	€ 1.520 SDN120GEPCLU	-	-	-	
BLACK	-	€ 1.520 SDN120GEPZU	-	-	-	

SHELL DINING 120  
 M 0,39 m³ 39,9 kgs

SHELL DINING 200  
TABLE

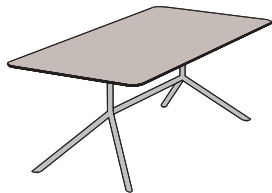

TOP: GLASS 10 mm	BASE:	BRUSHED STAINLESS STEEL	ELECTRO POLISHED STAINLESS STEEL	POWDERCOATED STAINLESS STEEL WHITE	POWDERCOATED STAINLESS STEEL CENDRE	POWDERCOATED STAINLESS STEEL BLACK
		WHITE	-	€ 1.200 SDN200GEPWU	-	-
CENDRE	-	€ 1.200 SDN200GEPCLU	-	-	-	
BLACK	-	€ 1.200 SDN200GEPZU	-	-	-	

SHELL DINING 200  
 M 1,22 m³ 87,9 kgs

PRODUCT

SHELL SALON  
SALON TABLE

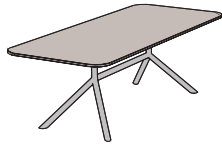

PRICES & REFERENCES

TOP: GLASS 10 mm	BASE:	BRUSHED STAINLESS STEEL	ELECTRO POLISHED STAINLESS STEEL	POWDERCOATED STAINLESS STEEL WHITE	POWDERCOATED STAINLESS STEEL CENDRE	POWDERCOATED STAINLESS STEEL BLACK
		WHITE	-	€ 1.180 SSLGEPWU	-	-
CENDRE	-	€ 1.180 SSLGEPCLU	-	-	-	
BLACK	-	€ 1.180 SSLGEPZU	-	-	-	

SPECS

SHELL SALON  
 M 0,18 m³ 25,9 kgs

SHELL SIDE 40  
SIDE TABLE



TOP: GLASS 10 mm	BASE:	BRUSHED STAINLESS STEEL	ELECTRO POLISHED STAINLESS STEEL	POWDERCOATED STAINLESS STEEL WHITE	POWDERCOATED STAINLESS STEEL CENDRE	POWDERCOATED STAINLESS STEEL BLACK
		WHITE	-	€ 440 SSD40GEPWU	-	-
CENDRE	-	€ 440 SSD40GEPCLU	-	-	-	
BLACK	-	€ 440 SSD40GEPZU	-	-	-	

SHELL SIDE 40  
 M 0,07 m³ 8,3 kgs

SHELL SIDE 50  
SIDE TABLE



TOP: GLASS 10 mm	BASE:	BRUSHED STAINLESS STEEL	ELECTRO POLISHED STAINLESS STEEL	POWDERCOATED STAINLESS STEEL WHITE	POWDERCOATED STAINLESS STEEL CENDRE	POWDERCOATED STAINLESS STEEL BLACK
		WHITE	-	€ 530 SSD50GEPWU	-	-
CENDRE	-	€ 530 SSD50GEPCLU	-	-	-	
BLACK	-	€ 530 SSD50GEPZU	-	-	-	

SHELL SIDE 50  
 M 0,08 m³ 8,4 kgs

# CUSHIONS SHELL COLLECTION & SCATTER CUSHIONS

## PRODUCT PRICES & REFERENCES SPECS

### SHELL CHAIR CUSHION



VERSION:	COLOUR:	WHITE	CAPPUCHINO / CENDRE	GREY	BLACK	NATTE DARK TAUPE	NATTE CARBON BEIGE	SUNBRELLA COMPLETE COLLECTION
STANDARD TEMPOTEST®	€ 95	PIL-SCR-WU	PIL-SCR-CAU	PIL-SCR-ROU	PIL-SCR-ZU	-	-	-
STANDARD SUNBRELLA®CAT.A	€ 130	-	-	-	-	PIL-SCR-NDT	PIL-SCR-NCB	CAT.A-CAT.B*

CUSHION SHELL CHAIR  
 M<sup>3</sup> 0,01 m<sup>3</sup> K<sup>g</sup> 0,4 kgs

### SHELL EASY CHAIR CUSHION



VERSION:	COLOUR:	WHITE	CAPPUCHINO / CENDRE	GREY	BLACK	NATTE DARK TAUPE	NATTE CARBON BEIGE	SUNBRELLA COMPLETE COLLECTION
STANDARD TEMPOTEST®	€ 110	PIL-SEC-WU	PIL-SEC-CAU	PIL-SEC-ROU	PIL-SEC-ZU	-	-	-
STANDARD SUNBRELLA®CAT.A	€ 150	-	-	-	-	PIL-SEC-NDT	PIL-SEC-NCB	CAT.A-CAT.B*

CUSHION SHELL EASY CHAIR  
 M<sup>3</sup> 0,02 m<sup>3</sup> K<sup>g</sup> 0,6 kgs

### SHELL SOFA CUSHION

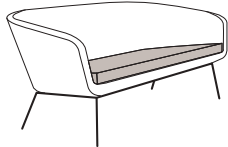

VERSION:	COLOUR:	WHITE	CAPPUCHINO / CENDRE	GREY	BLACK	NATTE DARK TAUPE	NATTE CARBON BEIGE	SUNBRELLA COMPLETE COLLECTION
STANDARD TEMPOTEST®	€ 210	PIL-SSF-WU	PIL-SSF-CAU	PIL-SSF-ROU	PIL-SSF-ZU	-	-	-
STANDARD SUNBRELLA®CAT.A	€ 250	-	-	-	-	PIL-SSF-NDT	PIL-SSF-NCB	CAT.A-CAT.B*

CUSHION SHELL SOFA  
 M<sup>3</sup> 0,05 m<sup>3</sup> K<sup>g</sup> 1,8 kgs

### SHELL SUNBED CUSHION

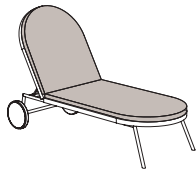

VERSION:	COLOUR:	WHITE	CAPPUCHINO / CENDRE	GREY	BLACK	NATTE DARK TAUPE	NATTE CARBON BEIGE	SUNBRELLA COMPLETE COLLECTION
STANDARD TEMPOTEST®	€ 430	PIL-SSB-WU	PIL-SSB-CAU	PIL-SSB-ROU	PIL-SSB-ZU	-	-	-
STANDARD SUNBRELLA®CAT.A	€ 460	-	-	-	-	PIL-SSB-NDT	PIL-SSB-NCB	CAT.A-CAT.B*

CUSHION SHELL SUNBED  
 M<sup>3</sup> 0,07 m<sup>3</sup> K<sup>g</sup> 2,8 kgs

\* + PRICE SUPPLEMENT

#### CUSHIONS: MATERIAL & COLOURS

TEMPOTEST®

100% SOLUTION DYED ACRYLIC FABRIC



WHITE (WU)

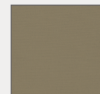

CAPPUCHINO (CAU)



GREY (ROU)



BLACK (ZU)

#### CUSHIONS: MATERIAL & COLOURS

SUNBRELLA®

100% SOLUTION DYED ACRYLIC FABRIC



NATTE DARK TAUPE (NDT)





NATTE CARBON BEIGE (NCB)

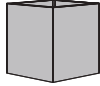
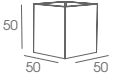

CAT.A - CAT.B\*

# ACCESSORIES & DECORATION

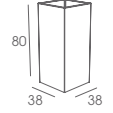
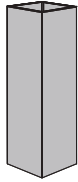
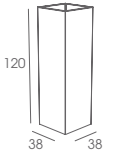
PRODUCT	PRICES & REFERENCES					SPECS	
<b>MACETERO 50</b> PLANTER 	FRAME:	BRUSHED STAINLESS STEEL	ELECTRO POLISHED STAINLESS STEEL	POWDERCOATED STAINLESS STEEL WHITE	POWDERCOATED STAINLESS STEEL CENDRE	POWDERCOATED STAINLESS STEEL BLACK	<b>MACETERO 50</b> 0.13 m <sup>3</sup> 24.4 kgs 
	MACETERO 50	€ 1.100 MCT50	€ 1.300 MCT50EP	€ 1.300 MCT50WR	€ 1.300 MCT50CAU	€ 1.300 MCT50A	
<b>MACETERO 80</b> PLANTER 	FRAME:	BRUSHED STAINLESS STEEL	ELECTRO POLISHED STAINLESS STEEL	POWDERCOATED STAINLESS STEEL WHITE	POWDERCOATED STAINLESS STEEL CENDRE	POWDERCOATED STAINLESS STEEL BLACK	<b>MACETERO 80</b> 0.13 m <sup>3</sup> 24.4 kgs 
	MACETERO 80	€ 1.100 MCT80	€ 1.300 MCT80EP	€ 1.300 MCT80WR	€ 1.300 MCT80CAU	€ 1.300 MCT80A	
<b>MACETERO 120</b> PLANTER 	FRAME:	BRUSHED STAINLESS STEEL	ELECTRO POLISHED STAINLESS STEEL	POWDERCOATED STAINLESS STEEL WHITE	POWDERCOATED STAINLESS STEEL CENDRE	POWDERCOATED STAINLESS STEEL BLACK	<b>MACETERO 120</b> 0.19 m <sup>3</sup> 34.0 kgs 
	MACETERO 120	€ 1.400 MCT120	€ 1.600 MCT120EP	€ 1.600 MCT120WR	€ 1.600 MCT120CAU	€ 1.600 MCT120A	

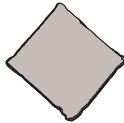
PRODUCT	PRICES & REFERENCES					SPECS	
<b>SCATTER CUSHION</b> 	VERSION:	COLOUR:	WHITE	CAPPUCHINO	GREY	BLACK	<b>SCATTER CUSHION PIL40</b> 40x40 cm 0.01 m <sup>3</sup> 0.4 kgs <b>SCATTER CUSHION PIL50</b> 50x50 cm 0.01 m <sup>3</sup> 0.5 kgs
	PIL 40 - STANDARD TEMPOTEST®	€ 75	PIL40RSWU	PIL40RSCAU	PIL40RSROU	PIL40RSZU	
	PIL 40 - STANDARD SUNBRELLA@CAT.A	€ 95	-	-	-	-	
	PIL 50 - STANDARD TEMPOTEST®	€ 110	PIL50RSWU	PIL50RSCAU	PIL50RSROU	PIL50RSZU	
	PIL 50 - STANDARD SUNBRELLA@CAT.A	€ 130	-	-	-	-	

# ACCESSORIES & DECORATION



## PRODUCT

FURNITURE OUTDOOR COVERS  
RAIN COVERS

## PRICES & REFERENCES

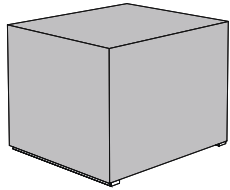
## SPECS



SIZE:			TYPE	REFERENCE	PRICE
					
75	93	80	COVER FOR POLTRONA LOUNGE	ODCPTL	€ 350
75	200	80	COVER FOR BANCA LOUNGE	ODCBCL	€ 390
75	290	80	COVER FOR POLTRONA+BANCA LOUNGE (MODULAR SYSTEM WITH CONNECTOR)	ODCBCLSP001	€ 550
33	93	80	COVER FOR PIECERA 78 LOUNGE	ODCPCL78	€ 220
33	93	132	COVER FOR PIECERA 130 LOUNGE	ODCPCL130	€ 250
33	93	212	COVER FOR SIESTA LOUNGE	ODCSTL	€ 360
35	152	62	COVER FOR TABLA 150 LOUNGE	ODCTLL150	€ 230
35	200	62	COVER FOR TABLA 200 LOUNGE	ODCTLL200	€ 250
35	80	80	COVER FOR MESITA 78 LOUNGE	ODCMSL78	€ 200
35	93	80	COVER FOR MESITA 91 LOUNGE	ODCMSL91	€ 220
75	152	152	COVER FOR TABLE & CHAIRS	ODCDNG150	€ 400
75	185	135	COVER FOR TABLE & CHAIRS	ODCDNG180	€ 460
OTHER SIZE COVERS ARE AVAILABLE ON REQUEST					

## MATERIAL & COLOUR

 **STAMOID®**  
Swiss made



STAMOID  
TAUPE



# MATERIALS

## STAINLESS STEEL

Stainless steel is commonly known as rust-free steel (RFS) or Inox. This is a ferrous alloy that increases the corrosion resistance of a substance by the addition of chrome and nickel. The principle is based on protecting the surface area by means of chrome-oxide and nickel-oxide molecules. These molecules are much larger than the underlying iron molecules, which prevents the latter from binding with oxygen and forming iron oxides – better known as rust.

In order to obtain a chrome-oxide and nickel-oxide surface that is of a high grade purity and homogeneity, thus achieving optimal corrosion resistance, the frames are etched and subjected to a passivating process as a standard treatment. Chlorine is RFS' greatest enemy and can cause a type of corrosion that is known as "pitting". For that reason, it is recommended that in locations near the seacoast - since sea salt is sodium chloride - the metal be given a surface made as smooth as possible in order to increase its resistance to corrosion even further. The smoother the surface, the less porous it is. The lower the porosity, the lower the possibility of dirt deposits accumulating on the metal surface, and thus the lower the risk of corrosion. For that reason, we recommend the optional electro-polishing treatment of the item's frame if it is to be used in a corrosive environment.

## BATYLINE®

Batyline® is a woven polyester fibre protected by a PVC coating. The fibres are then bundled together in order to obtain an exceptionally solid fibrous substance that is permanent, resistant to stretching, and immune to cracking.

Batyline® does not deform or create pockets: Précontraint® Ferrari® technology, basis of a unique process, ensures the fabrics outstanding dimensional stability. The most important feature is its pliancy and optimal seating comfort. Batyline® textiles offer excellent resistance to mould and mildew and benefit from surface treatment against UV degradation. This surface treatment also offers exceptional resistance to dirt.

Batyline® fabrics are eco-designed, ensuring optimum usage of resources and favouring safety, environmental impact reduction and incorporation of renewable raw materials. Its production facilities (in France and Switzerland) are ISO 14 001 certified and use green electricity and renewable energy sources.

All Batyline® textiles are certified Oeko-Tex. This label guarantees the absence of undesirable substances for you and those close to you.



## POWDER COATING

Powder coating is a type of coating that is applied as a free-flowing, dry powder. The main difference between a conventional liquid paint and a powder coating is that the powder coating does not require a solvent to keep the binder and filler parts in a liquid suspension form. The coating is typically applied electrostatically and is then cured under heat to allow it to flow and form a "skin". Because powder coating does not have a liquid carrier, it can produce thicker coatings than conventional liquid coatings without running or sagging, and powder coating produces minimal appearance differences between horizontally coated surfaces and vertically coated surfaces. The result of choosing a powder coated product is that it will have the most attractive, durable, high-quality finish available.

The powder may be a thermoplastic or a thermoset polymer. It is usually used to create a hard finish that is tougher than conventional paint. Powder coating is mainly used for coating of metals, such as household appliances and automobile and bicycle parts. The benefits of powder coating for consumers are simple: powder coating will make your purchase look better and last longer – not to mention its reduced environmental footprint!

## TEAK

Teak wood is produced by the Tectona Grandis, a tree that under favourable conditions can attain a height of up to 45 m, with a trunk diameter up to 2.4 meters. The wood's renowned durability is due to its high content of natural oils.

The limited absorption of moisture protects the wood from warping and thus gives the wood its enormous stability. In addition, the wood is highly resistant to attacks by pests. It is because of these qualities, as well as its exceptionally attractive hue and structure, that teak has deservedly received the title of "the noblest of all wood types".

In view of its high resistance, teakwood does not require additional protective measures. Nonetheless, a treatment to render the wood less sensitive to stains, or to keep the original colour of the wood, may be desired. Untreated wood, exposed to water and UV rays, will oxidise and take on a silver-grey sheen. It is simply a question of personal taste whether or not an individual wishes to allow the teak to "weather" to a silver-grey colour, or would rather maintain the original golden-brown colour of the wood.

# MATERIALS

## GLASS

Its resistance to staining and scratching makes glass a highly suitable material for tabletops in outdoor furniture. The glass used in the FueraDentro collection is available in white, cendre (Café latte) and black versions. They have a matt acid-washed finish, which is very scratch- and fingerprint resistant. Only the E-Volved table is available with extra clear transparent glass.

Glass surfaces may be cleaned with classic glass cleaners.

In the case of stubborn dirt and calcium deposits, "Glass Heavy Duty Cleaner" may be used. Use only for serious contamination. Avoid contact with skin and eyes. Extra protection is required.

## CERAMIC

The FueraDentro ceramic table tops consist of two 5mm slabs, which are glued together with a polyurethane / fibre glass resin. These slabs are made in porcelain stoneware and produced with an innovative technology, which compacts the material and then fires it in an electric kiln at temperatures over approx. 1220°C. This process is designed to ensure product uniformity, in addition to affording a modern appearance.

FueraDentro ceramic table tops are available in black, white and cendre colours, and will not fade over time.

Characteristics of ceramic which make it ideal for outdoor use are:

- it can be easily cleaned without affecting its surface characteristics.
- highly scratchproof and resistant to deep abrasion.
- a high breaking threshold.
- it is frost resistant and suitable for any weather condition.
- does not contain organic material therefore it is resistant to fire and high temperatures.
- perfectly suitable for food substances since it does not release elements in solution. It does not allow the formation of mould, bacteria and fungi.
- a totally natural product. It does not release any elements into the environment and can be easily milled and recycled in other manufacturing processes.
- does not contain organic pigments and is resistant to UV rays. Even if subjected to severe climate changes, the colours remain stable.

SPECIAL CERAMIC

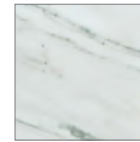

BS



CL



TR



TG



VB

## BELGIAN BLUESTONE

Belgian bluestone or "Little Granite" is a limestone with a more or less pronounced natural blue/grey colour, which is characterized by the presence of a large number of fossilized crinoids. This type of bluestone is only quarried in Belgium.

A beautiful limestone planking with a cool dark blue-gray colour palette with numerous inclusions. The inclusions are fossils of ancient sea life. Belgian Bluestone has humble origins and was used primarily as a ballast for ships and as road paving material. It became popular as an interior flooring material in the 19th century and can be found in luxury homes, exclusive hotels, and high-end retail stores throughout Europe. Precision cut with sawn sides and backs, it offers a consistently square piece. The colour consistency from piece to piece is good. It is a dense, durable material that is suitable for many applications.

- It develops a natural patina: use: outdoors, changes due to the action of rain and UV-rays to its original pale blue-grey colour use : indoors in the course of time, it develops a deeper colour
- Bluestone is susceptible to products and scratches
- Belgian bluestone can often contain a number of white veins, black lines, spots and fossils.
- Depending on the finishing, the stone has a different look "White veins" are water veins, formed by water, 100% specific to bluestone and are not cracks as people often assume.  
Fossils and colour differences: stone is a natural material formed by different perfectly petrified fossils. So it is normal to find nests of crustaceans in the stone. In other words, even in one sheet of stone clear differences in colour can be observed.

# FABRICS

## TEMPOTEST®

Tempotest® is a fabric particularly suitable for outdoor use. Tempotest® is woven from mass-coloured acrylic fibre; your security for optimal water- and UV resistance, plus years of optimal comfort. General information and maintenance.

Most stains on the material can be cleaned with mild soap and water. Simply remove dirt by scrubbing with water (under 40°C) and natural soap. Rinse liberally with clean water to remove all the soap. Removable covers can be washed at 40°C in the washing machine. Do not iron or spin dry. To prevent creasing replace the covers while still damp, and dry in the open air. Store the material in a dry, well-ventilated area in winter.

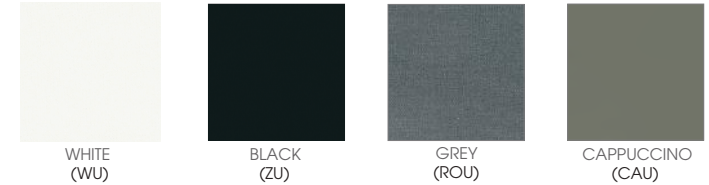

## SUNBRELLA®

Sunbrella fabrics give you the sophisticated style you want with the protection you need and are made to last for many seasons outdoors without fading; breathable and mold-resistant, they prevent condensation from heat and humidity. An anti-stain treatment safeguards your Sunbrella fabrics, which are machine-washable and provide effective protection against UV rays. The Sunbrella colors withstand sunlight and harsh weather conditions.

- QUICK PICK:** Natte dark taupe - Natte carbon beige  
**CAT. A:** Solids & Stripes - Solids Premium - Bengali - Checks - Dupione - Heritage  
 Natte - Sling Logan/Augustine  
**CAT. B:** Chartres - Deauve - Hexagon - Kanoko - Lopi - Marble - Mosaic - Palazzo  
 (+ price supplement): Robben - Savane - Sling Sailing - Tundra



Lead time for all Sunbrella fabrics: 2 - 4 weeks

## STAMSKIN®

Stamskin® is a fabric particularly suitable for outdoor use. With its unique elasticity and suppleness, this artificial leather offers outstanding seating comfort. General information and maintenance.

Stamskin®, produced by Serge Ferrari, benefits from a manufacturing technique which gives it incomparable flexibility. Its elegant appearance and pleasant feel are particularly appreciated. Comfortable, easy to care for and weather resistant, Stamskin® is known for its undeniable advantages.

Its strength, durability and easy care make Stamskin® a fabric particularly suitable for outdoor use. With its unique elasticity and suppleness, this synthetic leather offers outstanding seating comfort. The nature of its base-cloth and the composition of Stamskin Top® offers longevity. This material has an excellent resistance to ultraviolet radiation (UV) and is treated to resist micro-organism and mould. Stamskin Top® is classified flame retardant in accordance with current European fire safety standard.

STAMSKIN® WITHOUT BUTTONS



STAMSKIN® WITH BUTTONS



## STAMOID®

Stamoid is a vinyl coated woven polyester, completely waterproof, easily cleanable, cool to sit under, and folds and stores well. The high tenacity weave holds its shape and does not show humidity sagging problems common to lower marine grade fabrics. The vinyl sides are very easy to clean with a sponge and mild detergent.

FUERADENTRO

FUERADENTRO

WWW.FUERADENTRO.COM  
INFO@FUERADENTRO.COM

T +31 20 624 51 11

UPHOLSTERY  
**FABRIC**  
COLLECTION



**DESIGN + PERFORMANCE™**

# DESIGN + PERFORMANCE™

SUNBRELLA® WAS FOUNDED ON THE BELIEF THAT TEXTILES SHOULD BE BOTH FUNCTIONAL AND BEAUTIFUL.

FEATURING **SOPHISTICATED** PATTERNS AND LUXURIOUS TEXTURES, SUNBRELLA® FABRICS WILL CHALLENGE EXPECTATIONS AT EVERY TURN WITH **EXCEPTIONAL** DESIGN THAT'S EQUALLED ONLY BY ITS LEGENDARY **PERFORMANCE**. SUNBRELLA® FABRICS ARE NOT SIMPLY AT THE FOREFRONT OF STYLE, BUT AT THE LEADING EDGE OF INNOVATION, INSPIRED BY THE **BOUNDLESS CREATIVITY** AND LASTING IMPACT OF THE ART, FASHION AND **DESIGN** WORLDS■



# SUNBRELLA® SOLIDS & STRIPES



SJA 5404 137  
**NATURAL**

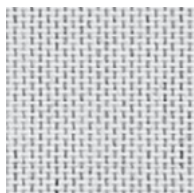

SJA 3966 137  
**MARBLE**



SJA 3741 137  
**SILVER GREY**



SJA 3706 137  
**SHINGLES**



SJA 3756 137  
**LEAD CHINÉ**



SJA 3777 137  
**PORTO GREY CHINÉ** | REPEAT/RAPPORT: 19,95cm



SJA 3757 137  
**FLANELLE**



SJA 3737 137  
**ARDOISE**

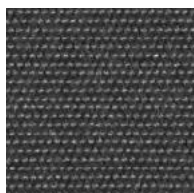

SJA 3906 137  
**CARBON**



SJA 3705 137  
**CHARCOAL**

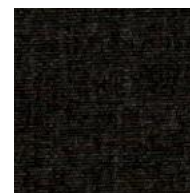

SJA 3758 137  
**SOOTY**



SJA 5408 137  
**BLACK**



SJA 3778 137  
**QUADRI GREY** | REPEAT/RAPPORT: 22,71cm



SJA 3974 137  
**SINTRA GREY** | REPEAT/RAPPORT: 19,80cm



# SUNBRELLA® SOLIDS & STRIPES

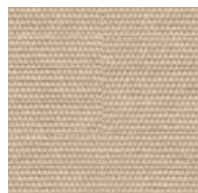

SJA 5422 137  
**ANTIQUÉ BEIGE**



SJA 5476 137  
**HEATHER BEIGE**



SJA 3907 137  
**TAUPE CHINÉ**



SJA 3729 137  
**TAUPE**

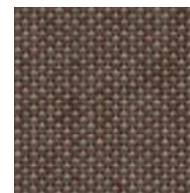

SJA 3127 137  
**MINK BROWN**

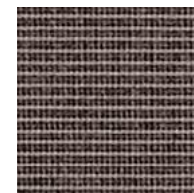

SJA 3792 137  
**DARK SMOKE**

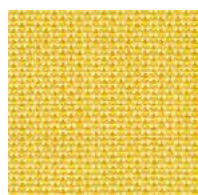

SJA 3937 137  
**LEMON**



SJA 3938 137  
**MIMOSA**

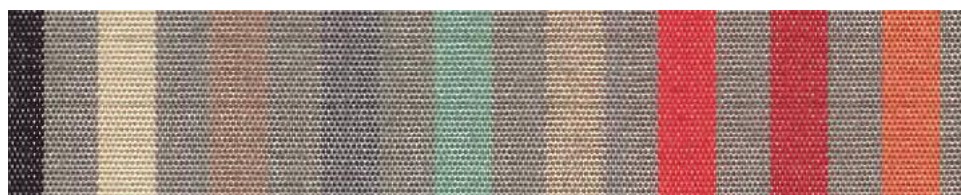

SJA 3954 137  
**CONFETTI RED** | REPEAT/RAPPORT: 19,38cm

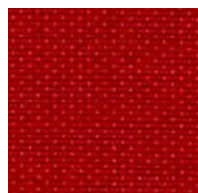

SJA 3968 137  
**PEPPER**



SJA 3728 137  
**PARIS RED**



SJA 5436 137  
**BURGUNDY**



SJA 3905 137  
**PINK**

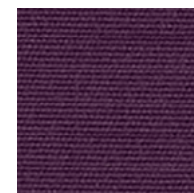

SJA 3718 137  
**PLUM**

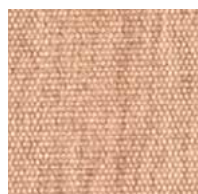

SJA 3962 137  
**PEACH**

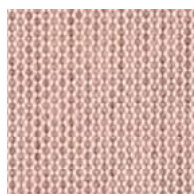

SJA 3965 137  
**BLUSH**

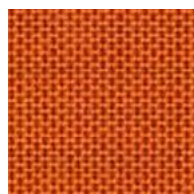

SJA 3969 137  
**PUMPKIN**

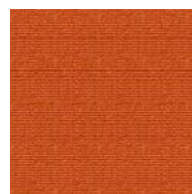

SJA 5417 137  
**TUSCANY**



SJA 3939 137  
**PAPRIKA**



SJA 5477 137  
**LOGO RED**



SJA 3971 137  
**FIGARI RED** | REPEAT/RAPPORT: 27,73cm

# SUNBRELLA® SOLIDS & STRIPES

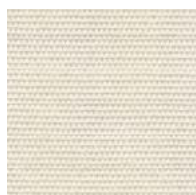

SJA 3943 137  
**NACRE**



SJA 5453 137  
**CANVAS**

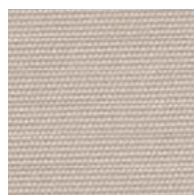

SJA 3960 137  
**ARGILE**



SJA 3780 137  
**LIN**



SJA 48009 137  
**ARBOR PEBBLE**



SJA 3975 137  
**SINTRA GREEN** | REPEAT/RAPPORT: 19,80cm



SJA 3956 137  
**CONFETTI YELLOW** | REPEAT/RAPPORT: 19,38cm



SJA 3945 137  
**GRANNY**



SJA 3738 137  
**MACAO**

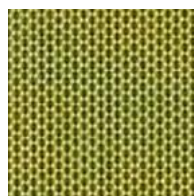

SJA 3970 137  
**LICHEN**



SJA 3967 137  
**MINT**

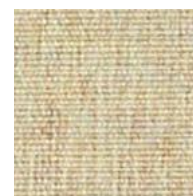

SJA 3963 137  
**EGGSHELL**



SJA 3936 137  
**LIME**



SJA 3957 137  
**CONFETTI GREEN** | REPEAT/RAPPORT: 19,38cm

# SUNBRELLA® SOLIDS & STRIPES

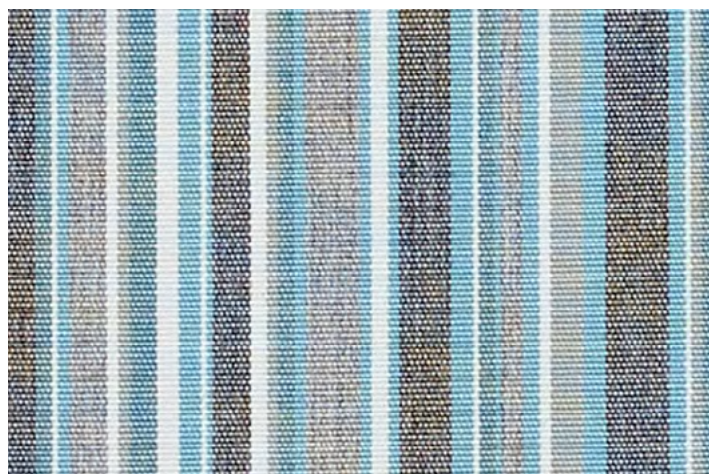

SJA 3776 137  
**PORTO BLUE CHINÉ** | REPEAT/RAPPORT: 19,95cm

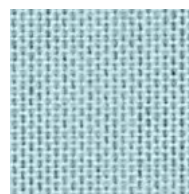

SJA 3964 137  
**CURAÇAO**



SJA 3940 137  
**POLAR BLUE**

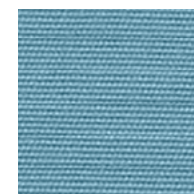

SJA 5420 137  
**MINERAL BLUE**

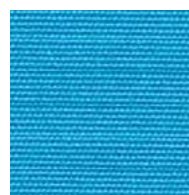

SJA 3961 137  
**AZURE**

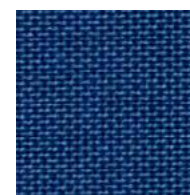

SJA 3717 137  
**RIVIERA BLUE**



SJA 5499 137  
**TRUE BLUE**



SJA 3973 137  
**SINTRA BLUE** | REPEAT/RAPPORT: 19,80cm

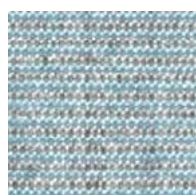

SJA 3793 137  
**MINERAL BLUE CHINÉ**



SJA 5416 137  
**ARUBA**



SJA 3941 137  
**ADRIATIC**



SJA 3944 137  
**CHARRON**



SJA 3942 137  
**BLUE STORM**

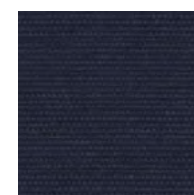

SJA 5439 137  
**NAVY BLUE**



SJA 3972 137  
**FIGARI PEACOCK** | REPEAT/RAPPORT: 27,73cm

# SUNBRELLA® HEXAGON

REPEAT / RAPPORT:  
50,7 cm ↓ 14,22 cm

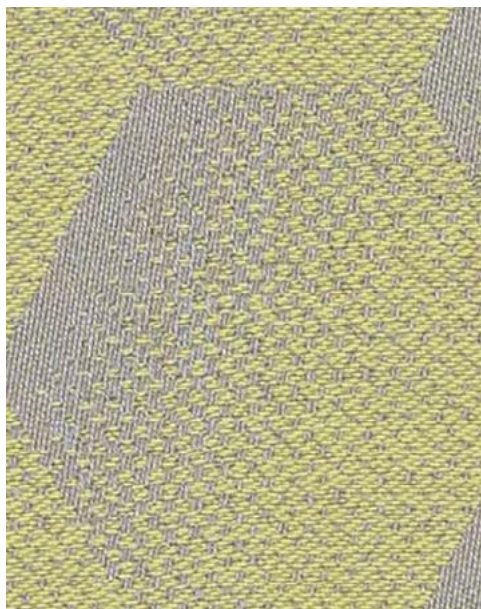

HEX J207 140  
**LEMON**

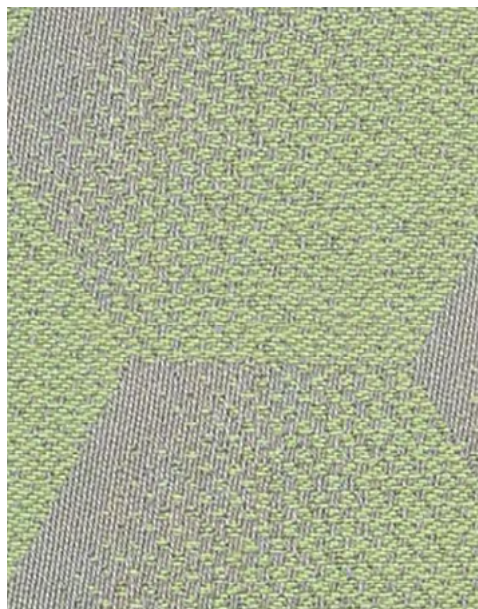

HEX J206 140  
**MINT**

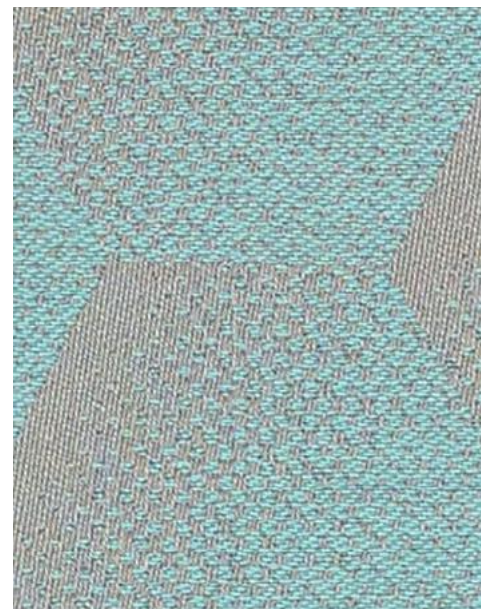

HEX J205 140  
**ACQUA**

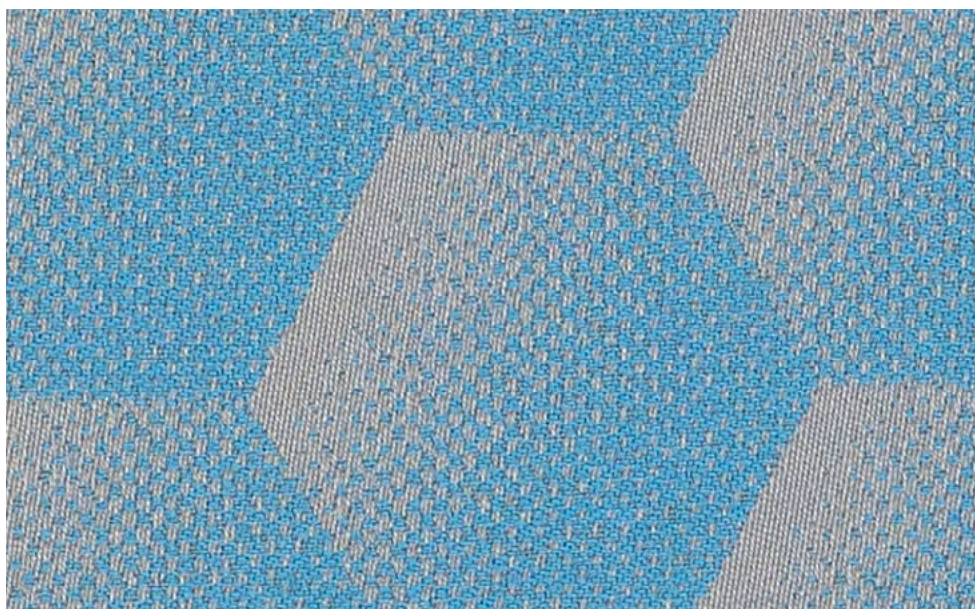

HEX J204 140  
**AZURE**



HEX J203 140  
**PINK**

# SUNBRELLA® NATTÉ



NAT 10014 140  
**NATURE**



NAT 10021 140  
**CANVAS**



NAT 10151 140  
**LINEN CHALK**



NAT 10150 140  
**HEATHER CHALK**



NAT 10155 140  
**TAUPE CHALK**



NAT 10028 140  
**HEATHER BEIGE**



NAT 10029 140  
**HEATHER GREY**

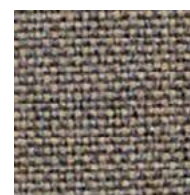

NAT 10065 140  
**CARBON BEIGE**

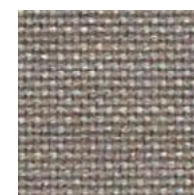

NAT 10040 140  
**NATURE GREY**



NAT 10153 140  
**FLANELLE CHALK**

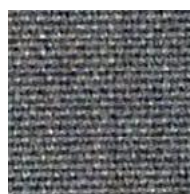

NAT 10063 140  
**CHARCOAL CHINÉ**

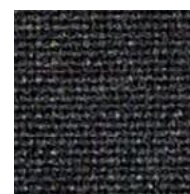

NAT 10030 140  
**SOOTY**



NAT 10059 140  
**DARK TAUPE**

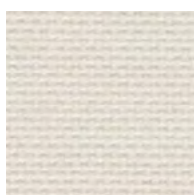

NAT 10020 140  
**WHITE**



NAT 10154 140  
**STORM CHALK**



NAT 10022 140  
**GREY CHINÉ**



NAT 10025 140  
**FROSTY CHINÉ**



NAT 10064 140  
**CARBON SKY**



NAT 10152 140  
**GRAUMEL CHALK**

# SUNBRELLA® CHECKS



CHE F057 140  
**EDWARD RED** | REPEAT/RAPPORT:  $\leftarrow 27\text{ cm} \rightarrow$   $\updownarrow 22\text{ cm}$



CHE F058 140  
**EDWARD PEACOCK** | REPEAT/RAPPORT:  $\leftarrow 27\text{ cm} \rightarrow$   $\updownarrow 22\text{ cm}$

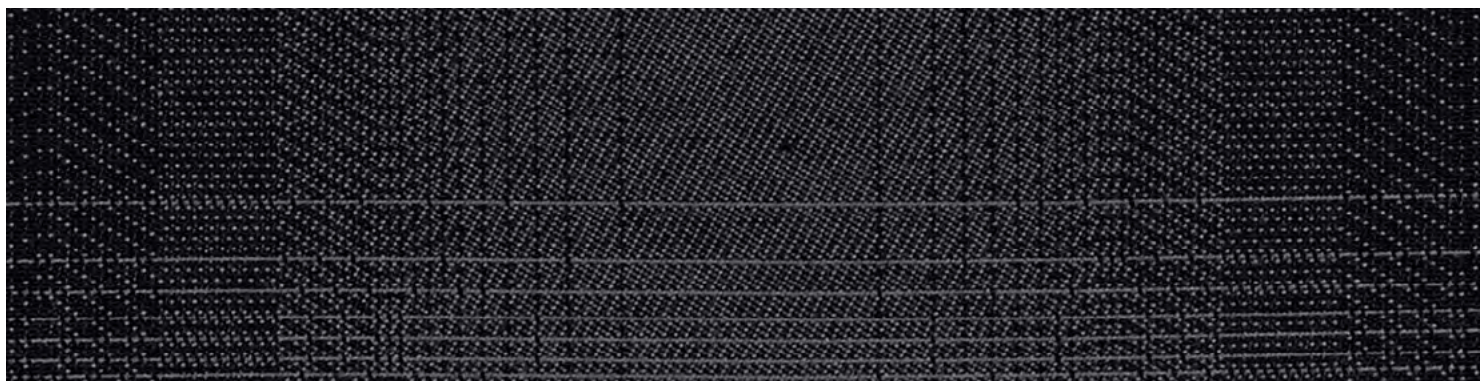

CHE F056 140  
**CONNOR BLACK** | REPEAT/RAPPORT:  $\leftarrow 27,4\text{ cm} \rightarrow$   $\updownarrow 26,5\text{ cm}$

# SUNBRELLA® ROBBEN



ROB R032 140  
**SILVER**



ROB R001 140  
**SKY**



ROB R011 140  
**OCEAN**



ROB R030 140  
**GREY**



ROB R005 140  
**STORM**



ROB R031 140  
**ANTIQUE**



ROB R008 140  
**HEMP**



ROB R009 140  
**TAUPE**

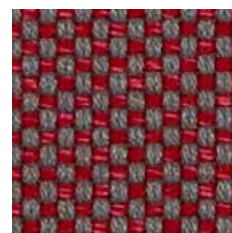

ROB R012 140  
**DRAMA**



ROB R007 140  
**PLUM**



ROB R004 140  
**STRAW**



ROB R003 140  
**WHEAT**



ROB R002 140  
**LICHEN**

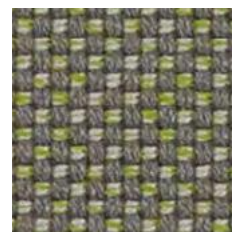

ROB R006 140  
**LEAF**

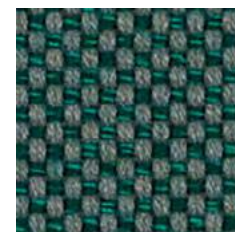

ROB R010 140  
**FOREST**

# SUNBRELLA® CHECKS

REPEAT / RAPPORT:  
0,80 cm ↓ 0,70 cm



CHE F061 140  
**OLIVER YELLOW**

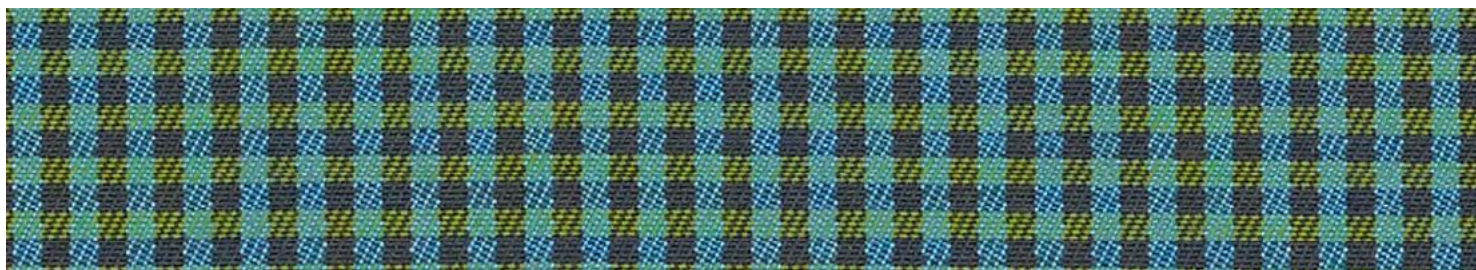

CHE F059 140  
**OLIVER GREEN**



CHE F060 140  
**OLIVER LILAC**



CHE F062 140  
**OLIVER BLUE**



# SUNBRELLA® BENGALI

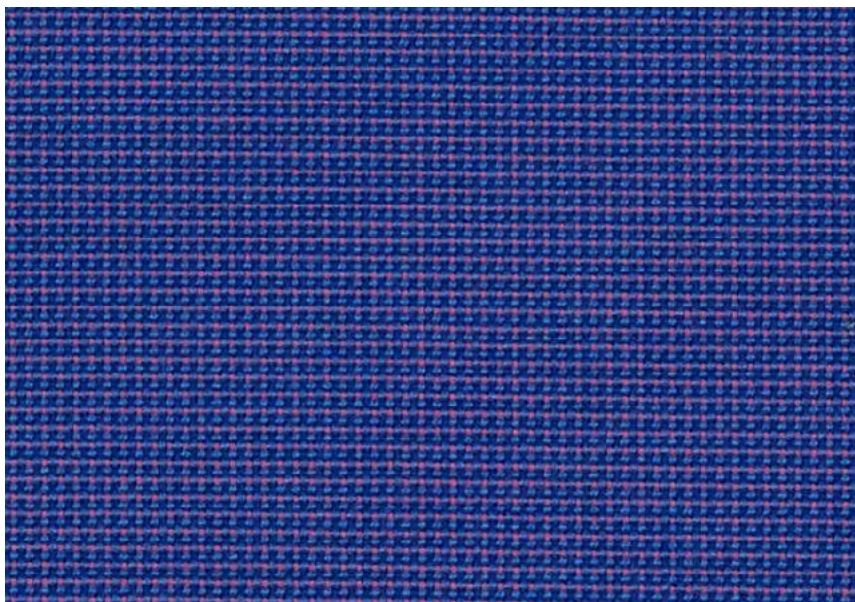

BEN 10162 140  
**VIOLET**



BEN 10161 140  
**PURPLE**

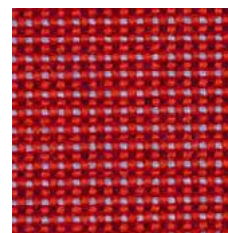

BEN 10158 140  
**CHERRY**



BEN 10159 140  
**RED**



BEN 10168 140  
**MINT**

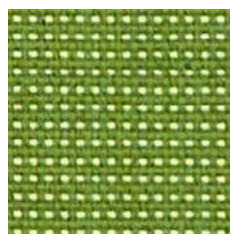

BEN 10167 140  
**BAMBOO**

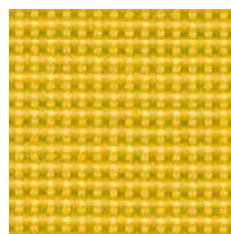

BEN 10156 140  
**YELLOW**

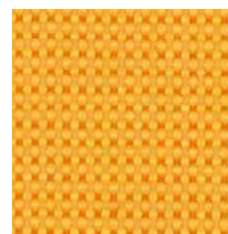

BEN 10157 140  
**ORANGE**

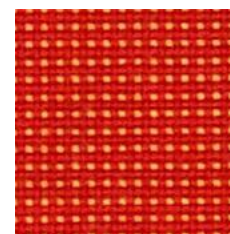

BEN 10160 140  
**PAPAYA**

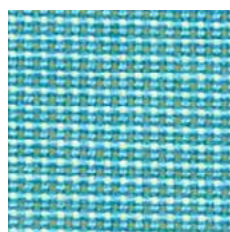

BEN 10164 140  
**SKY**

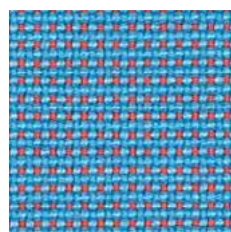

BEN 10165 140  
**OPTIC ORANGE**

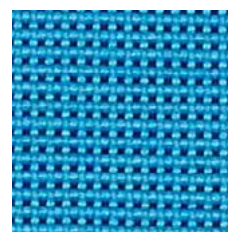

BEN 10166 140  
**CAPRI**

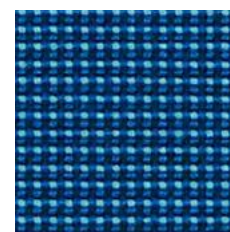

BEN 10163 140  
**OCEAN**

	STANDARDS NORMES	SOLIDS & STRIPES	BENGALI
COMPOSITION			
FINISH FINITION			
MINIMUM USEFULL WIDTH LAIZE UTILE MINI/CM	EN 1773	137	
WEIGHT POIDS	ISO 3801 g/sqm - g/m <sup>2</sup>	260	275
ROLL LENGTH LONGUEUR ROULEAU	LM ML		
SPRAY TEST DÉPERLANCE	ISO 4920 Class/5		
COLOUR FASTNESS UV INDOOR SOLIDITÉ COULEURS UV INDOOR	ISO 105B02 Class/8		
COLOUR FASTNESS TO WEATHER OUTDOOR SOLIDITÉ COLORIS INTEMPÉRIES OUTDOOR	ISO 105B04 1000 h Class/5		
COLOUR FASTNESS DRY FRICTION SOLIDITÉ COLORIS FROTTEMENT SEC	ISO 105X12 Class/5		
COLOUR FASTNESS WET FRICTION SOLIDITÉ COLORIS FROTTEMENT HUMIDE	ISO 105X12 Class/5		
CARE INSTRUCTIONS ENTRETIEN			Ironing r

CHECKS  
Edward - Connor - Oliver

NATTÉ

HEXAGON

ROBBEN

100 % Sunbrella® Acrylic  
100% Acrylique Sunbrella®

Water-Repellent & Stain-Proof  
Déperlant & Anti-Taches

140

250

275

310

630

50

25

5

4

8

4-5

5

5



reinforces the treatment - Le repassage renforce le traitement

\* Hexagon, Robben : cold washing - lavage à froid



BLEACH  
CLEANABLE



BREATHABLE  
COMFORT



MOLD/MILDEW  
RESISTANT



WATER & STAIN  
RESISTANT



SUN  
PROTECTION



UV/FADE  
RESISTANT



LANDFILL  
FREE

## ZERO LANDFILL

For over 30 years, Sunbrella® has recycled its industrial wastes such as yarn and packaging. Today, every Sunbrella® manufacturing facility around the globe sends absolutely no waste to the landfill.



## SKIN PROTECTION

The Skin Cancer Foundation recommends Sunbrella® fabrics in shading products as an aid in the prevention of sun-induced damage to the skin as a part of a complete sun protection regimen, including regular use of sunscreen.



## GREENGUARD CERTIFIED

Sunbrella® upholstery fabric has achieved GREENGUARD GOLD Certification. Sunbrella® upholstery fabrics are certified by GREENGUARD as contributing to healthy indoor air by being a very low emitting interior product.



## OEKO-TEX LABEL

A quality that meets human-ecological requirements. Awarded with the OEKO-TEX label (class II – products with direct contact to the skin), Sunbrella® fabrics are made without any identified harmful substance that could be a danger to health, skin and the environment.



FOR DETAILED WARRANTY INFORMATION  
VISIT [WWW.SUNBRELLA.COM/WARRANTY](http://WWW.SUNBRELLA.COM/WARRANTY)



NEW DANDY





TROPIC SPIRIT





BLACK ATTITUDE





NEW DANDY





DESIGN + PERFORMANCE™

[www.sunbrella.com](http://www.sunbrella.com)

EDITION OCTOBER 2017 - SAS DICKSON CONSTANT - CAPITAL 12.640.000 EUROS - 381 347 970 R.C.S. LILLE MÉTROPOLE  
CRÉATION : LIKE A FREE - CRÉDIT PHOTO : OLI&CO - SUNBRELLA® IS A REGISTERED TRADEMARK OF GLEN RAVEN, INC.



UPHOLSTERY  
**FABRIC**  
COLLECTION



**DESIGN + PERFORMANCE™**

# DESIGN + PERFORMANCE™

THE COMPETITIVE LANDSCAPE IS FULL OF ORDINARY. WE REFUSE TO BE ORDINARY. SUNBRELLA® CHALLENGES THE STATUS QUO IN DESIGN, NOT ONLY RIVALLING ANY HIGH-END FABRIC OR TREND-FORWARD PATTERN AND TEXTURE, BUT ALSO OFFERING WELL-KNOWN PERFORMANCE. WE INTEGRATE STYLE AND FUNCTION INTO EVERY EXTRAORDINARY TEXTILE WE CREATE ■



# SUNBRELLA® PALAZZO



PAL J229 140  
**SILVER**

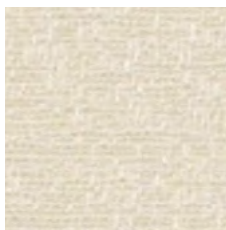

PAL J222 140  
**IVORY**



PAL J230 140  
**STRAW**

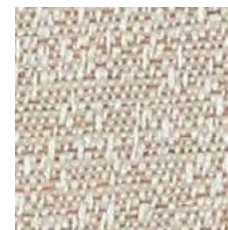

PAL J228 140  
**ANTIQUE**



PAL J227 140  
**GREY**



PAL J223 140  
**MINERAL**



PAL J224 140  
**GLACIER**



PAL J226 140  
**MINT**



PAL J225 140  
**LICHEN**



# SUNBRELLA® MARBLE

REPEAT / RAPPORT:  
← 140 cm → ↓ 163,41 cm



MAR J231 140  
**GREY**



MAR J232 140  
**GLACIER**



# SUNBRELLA® DUPIONE



DUP P030 140  
**SHADE**



DUP P049 140  
**ARGILE**



DUP 8011 140  
**SAND**

# SUNBRELLA® DEAUVE

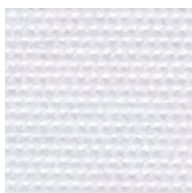

DEA 5404 140  
**WHITE**



DEA 3977 140  
**CHALK**

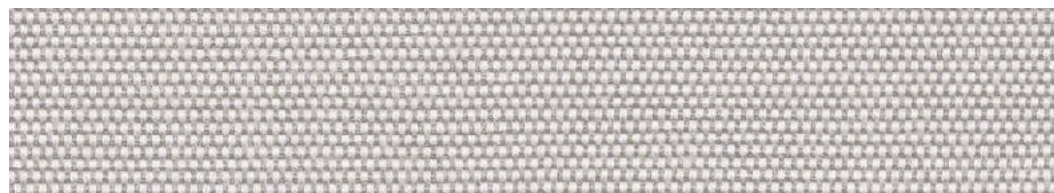

DEA 3741 140  
**SILVER GREY**



DEA 5453 140  
**CANVAS**



DEA 3960 140  
**ARGILE**



DEA 3976 140  
**CLAY**



DEA 3729 140  
**TAUPE**

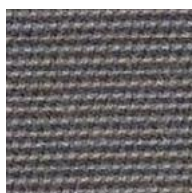

DEA 3737 140  
**ARDOISE**



DEA 5032 140  
**BLACK**

# SUNBRELLA® TUNDRA



TUN J217 140  
**ARGILE**



TUN J215 140  
**ANTIQUE**



TUN J220 140  
**QUARTZ**



TUN J213 140  
**MOSS**



TUN J214 140  
**STRAW**

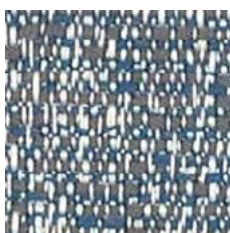

TUN J219 140  
**SLATE**



TUN J218 140  
**CHARCOAL**



TUN J221 140  
**GRANIT**

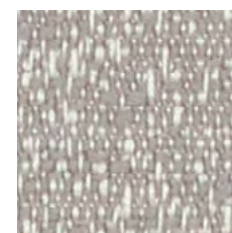

TUN J216 140  
**GREY**

# SUNBRELLA® KANOKO

REPEAT / RAPPORT:  
31,5cm ↓ 64cm



KAN J208 140  
**NATURAL**



KAN J209 140  
**ANTIQUE**



KAN J210 140  
**GREY**



KAN J212 140  
**STORM**

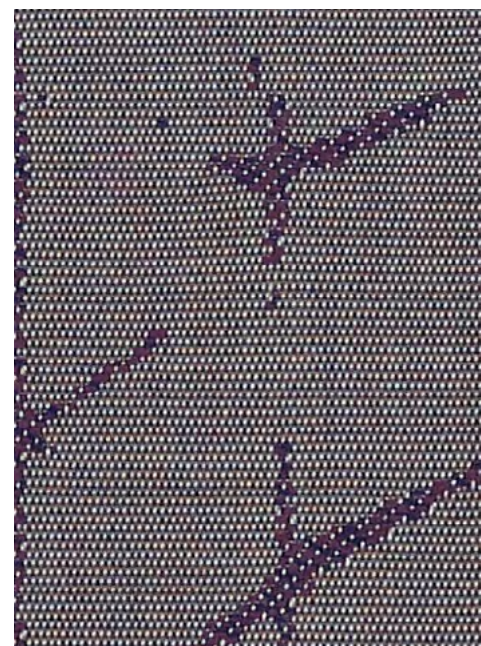

KAN J211 140  
**PLUM**

# SUNBRELLA® SAVANE

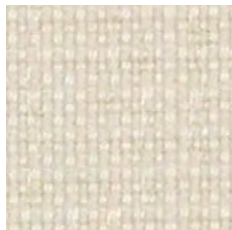

SAV J235 140  
**WHITE**



SAV J238 140  
**CANVAS**



SAV J233 140  
**COCONUT**



SAV J239 140  
**SILVER**



SAV J234 140  
**GREY**



SAV J240 140  
**GRANIT**



SAV J236 140  
**ZINC**



SAV J241 140  
**FLANELLE**

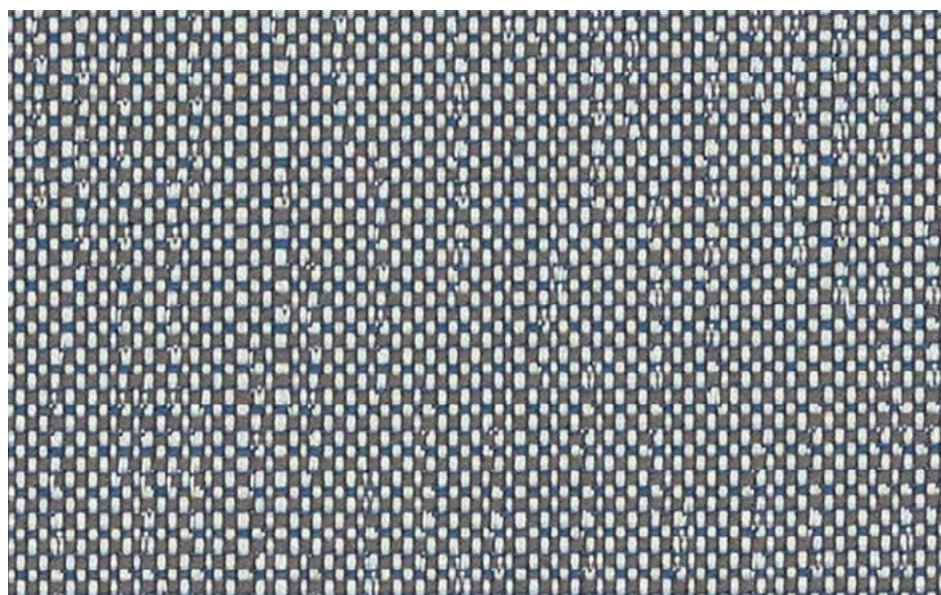

SAV J237 140  
**STORM**

# SUNBRELLA® CHARTRES



CHA J193 140  
**PEARL**

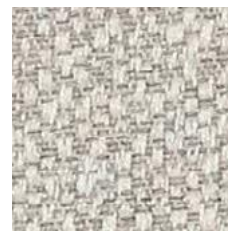

CHA J194 140  
**SILVER**



CHA J192 140  
**LICHEN**



CHA J188 140  
**MINT**



CHA J184 140  
**ROSE**



CHA J190 140  
**GOLD**



CHA J186 140  
**ANTIQUE**



CHA J189 140  
**HEATHER**



CHA J181 140  
**BRONZE**



CHA J187 140  
**GLACIER**



CHA J185 140  
**MINERAL**



CHA J191 140  
**GREY**



CHA J183 140  
**FLANELLE**



CHA J182 140  
**SOOTY**

# SUNBRELLA® MOSAÏC

REPEAT / RAPPORT:  
4,52cm → ↑ 5,14cm



MOS J197 136  
**LIME**



MOS J196 136  
**YELLOW**



MOS J195 136  
**MANDARINE**



MOS J199 136  
**GLACIER**



MOS J198 136  
**BLUE**

# SUNBRELLA® LOPI

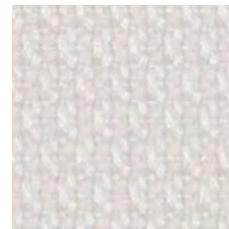

LOP R033 140  
**SNOW**

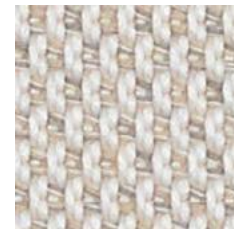

LOP R018 140  
**MARBLE**



LOP R013 140  
**SHADOW**



LOP R017 140  
**CHARCOAL**



LOP R015 140  
**SILVER**

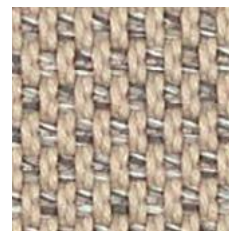

LOP R019 140  
**SAND**



LOP R034 140  
**ANTIQUE**

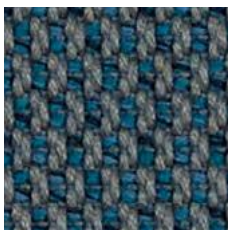

LOP R029 140  
**STORM**



LOP R028 140  
**CLOUD**

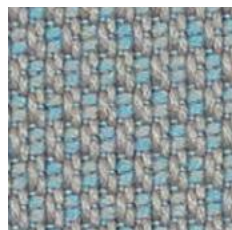

LOP R027 140  
**STEEL**

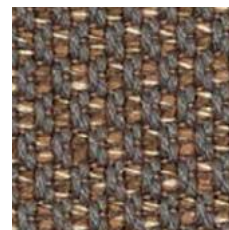

LOP R014 140  
**COCONUT**



LOP R016 140  
**HEMP**



LOP R026 140  
**GLACIER**



LOP R020 140  
**VANILLA**



LOP R021 140  
**LIME**

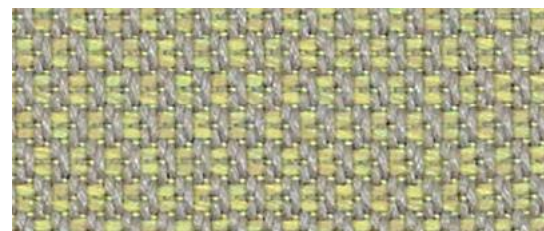

LOP R022 140  
**PISTACHE**



LOP R023 140  
**BLUSH**



LOP R024 140  
**PEACH**



LOP R025 140  
**CORAL**

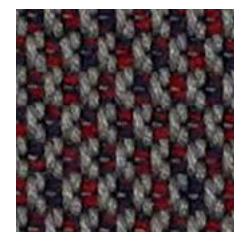

LOP R035 140  
**PLUM**



# SUNBRELLA® HERITAGE

RENAISSANCE



50% RECYCLED  
CONTENT

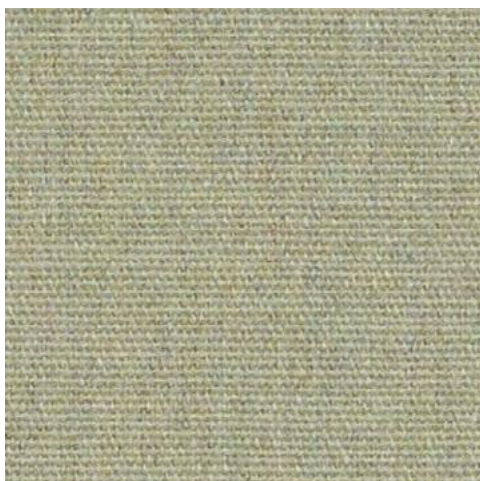

SJA 18012 00 137  
**MOSS**



SJA 18011 00 137  
**LEAF**



SJA 18010 00 137  
**DENIM**

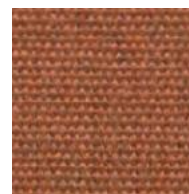

SJA 18007 00 137  
**PUMPKIN**

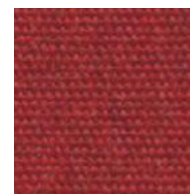

SJA 18003 00 137  
**GARNET**



SJA 18006 00 137  
**PAPYRUS**



SJA 18001 00 137  
**ASH**



SJA 18004 00 137  
**GRANITE**

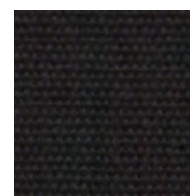

SJA 18009 00 137  
**CHAR**

# SUNBRELLA® SLING



LOGAN



SAILING



AUGUSTINE



SLI 50045 07 137  
**LOGAN SNOWY**



SLI 50045 06 137  
**LOGAN SAND**



SLI 50045 00 137  
**LOGAN CHARCOAL**

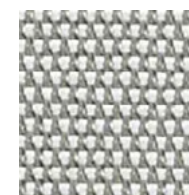

SLI 50143 10 137  
**SAILING SEAGULL**

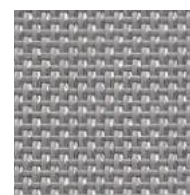

SLI 5928 44 137  
**AUGUSTINE SILVER**



SLI 50045 02 137  
**LOGAN TAUPE**



SLI 50045 18 137  
**LOGAN GRAPHITE**

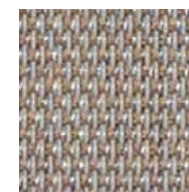





SLI 50143 19 137  
**SAILING SPACE**



SLI 5928 43 137  
**AUGUSTINE DENIM**

	STANDARDS NORMES	LOPI	PALAZZO	SAVANE	TUNDRA	CHARTRES	DEAUV
COMPOSITION	100% Sunbrella® Acrylic 100% Acrylique Sunbrella®						
FINISH FINITION							
MINIMUM USEFULL WIDTH LAIZE UTILE MINI/CM	EN 1773	140					
WEIGHT POIDS	ISO 3801 g/sqm - g/m <sup>2</sup>	680	330	400		375	335
ROLL LENGTH LONGUEUR ROULEAU	LM ML	25	50		35		
SPRAY TEST DÉPERLANCE	ISO 4920 Class/5	4					
COLOUR FASTNESS UV INDOOR SOLIDITÉ COULEURS UV INDOOR	ISO 105B02 Class/8						
COLOUR FASTNESS TO WEATHER OUTDOOR SOLIDITÉ COLORIS INTEMPÉRIES OUTDOOR	ISO 105B04 1000 h Class/5						
COLOUR FASTNESS DRY FRICTION SOLIDITÉ COLORIS FROTTEMENT SEC	ISO 105X12 Class/5						
COLOUR FASTNESS WET FRICTION SOLIDITÉ COLORIS FROTTEMENT HUMIDE	ISO 105X12 Class/5						
CARE INSTRUCTIONS ENTRETIEN	Ironing reinforces the treatment - Le repassage renforce le traitement						

	DUPIONE	KANOKO	MARBLE	MOSAIC	HERITAGE	SLING AUGUSTINE	SLING LOGAN	SLING SAILING	
					50% recycled Sunbrella® Acrylic 47% Sunbrella® Acrylic 3% Polyester	11% Sunbrella® Acrylic 25% Polyester 64% PVC	19% Sunbrella® Acrylic 22% Polyester 59% PVC	35% Sunbrella® Acrylic 17,8% Polyester 47,2% PVC	
Water-Repellent & Stain-Proof Déperlant & Anti-Taches									
				140	137				
	310	360	330	566	335	505	480	580	
	50			35	55	40			
	5					—			
	8								
	4-5								
	5								
	5								
	    								
usage renforce le traitement						—			

\* Lopi, Palazzo, Savane, Tundra : cold washing - lavage à froid \*\* Sling : do not iron - repassage interdit



BLEACH  
CLEANABLE



BREATHABLE  
COMFORT



MOLD/MILDEW  
RESISTANT



WATER & STAIN  
RESISTANT



SUN  
PROTECTION



UV/FADE  
RESISTANT



LANDFILL  
FREE

## ZERO LANDFILL

For over 30 years, Sunbrella® has recycled its industrial wastes such as yarn and packaging. Today, every Sunbrella® manufacturing facility around the globe sends absolutely no waste to the landfill.



## SKIN PROTECTION

The Skin Cancer Foundation recommends Sunbrella® fabrics in shading products as an aid in the prevention of sun-induced damage to the skin as a part of a complete sun protection regimen, including regular use of sunscreen.



## GREENGUARD CERTIFIED\*

Sunbrella® upholstery fabric has achieved GREENGUARD GOLD Certification. Sunbrella® upholstery fabrics are certified by GREENGUARD as contributing to healthy indoor air by being a very low emitting interior product.



## OEKO-TEX LABEL\*

A quality that meets human-ecological requirements. Awarded with the OEKO-TEX label (class II – products with direct contact to the skin), Sunbrella® fabrics are made without any identified harmful substance that could be a danger to health, skin and the environment.



LIMITED WARRANTY

FOR DETAILED WARRANTY INFORMATION  
VISIT [WWW.SUNBRELLA.COM/WARRANTY](http://WWW.SUNBRELLA.COM/WARRANTY).

\* except for Heritage and Sling



MAGIE BLANCHE

PURE NATURE









MISTY ROSE





SCANDINAVIAN INDUS

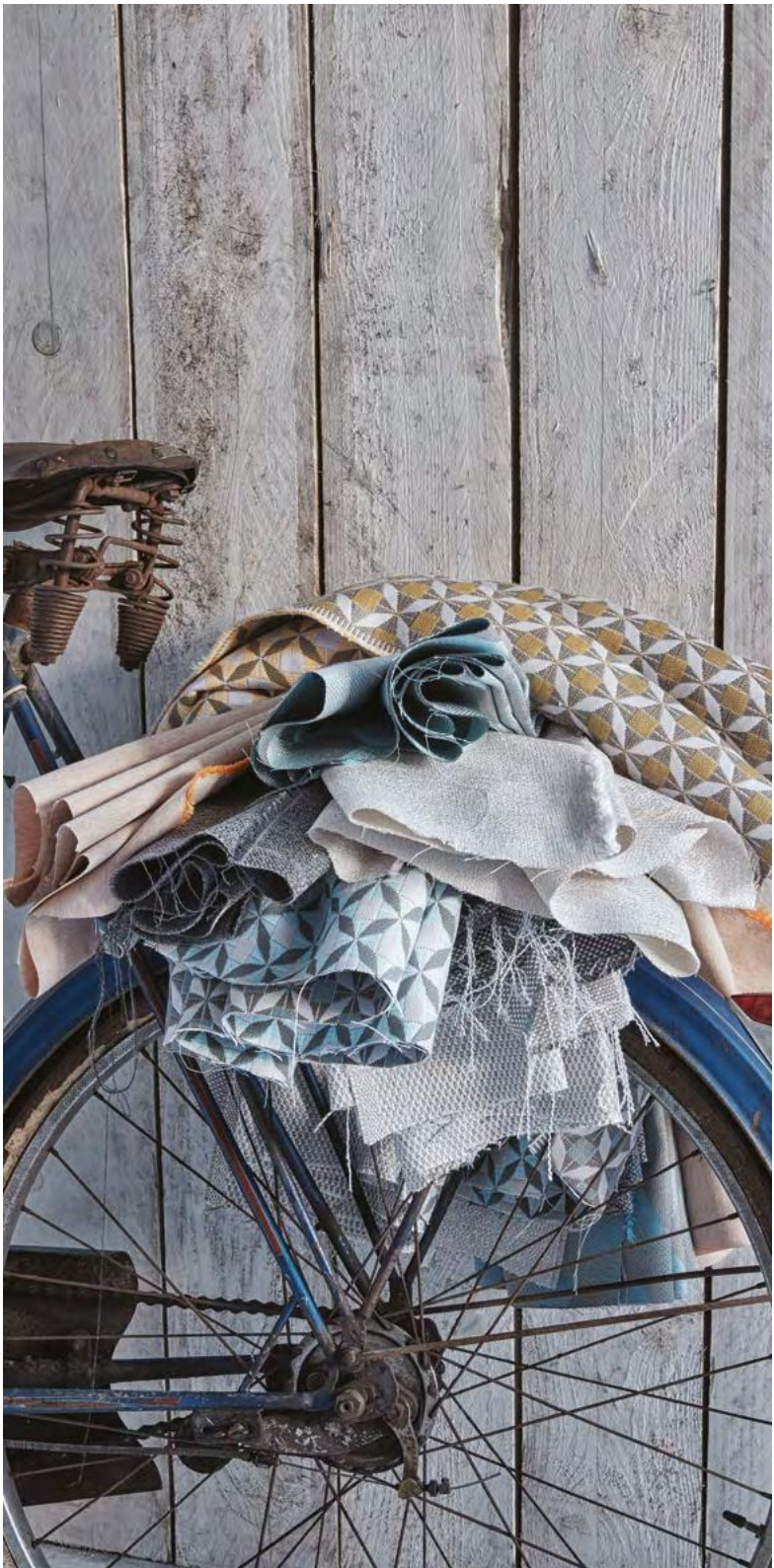



DESIGN + PERFORMANCE™

[www.sunbrella.com](http://www.sunbrella.com)

EDITION OCTOBER 2017 - SAS DICKSON CONSTANT - CAPITAL 12.640.000 EUROS - 381 347 970 R.C.S. LILLE MÉTROPOLE  
CRÉATION : LIKE A FREE - CRÉDIT PHOTO : OLI&CO - SUNBRELLA® IS A REGISTERED TRADEMARK OF GLEN RAVEN, INC.

